

---

# Towards Net Zero Carbon

## Achieving greater carbon reductions on site

### The role of carbon pricing

---



May 2020 | Rev M



## 1. The climate emergency and buildings in London

- There is a climate emergency (p.7)
- Reducing energy use in new buildings (p.8)
- The low carbon electricity revolution (p.9)
- What is low carbon heat? (p.10)
- Fuel poverty and affordability of heat (p.11)
- Towards Net Zero Carbon buildings (p.12)

## 2. What are the issues with the current approach to offsetting?

- Issues with the 35% on-site carbon reduction requirement (p.14)
- Issues with carbon offsetting (p.15)
- Issues with the metric and methodology (p.16)
- The role of the planning system (p.17)

## 3. How can carbon pricing incentivise greater carbon reductions on-site?

- Current approach to carbon offsetting (p.19)
- Our methodology (p.20)  
For each typology:
- Part L performance
- Capital cost
- Carbon offsetting scenarios
- Will the carbon price be sufficient to save carbon off-site? (p. 41)
- Conclusion (p.42)

## 4. Beyond Part L – we need to use predicted energy to achieve Net Zero

- Accuracy of carbon savings estimate for domestic buildings (p.44)
- Accuracy of carbon savings estimate for non-domestic buildings (p.45)
- Is it a Net Zero Carbon building? (p.46)
- Energy Use Intensity (EUI) (p.47)
- Towards Net Zero Carbon buildings: a better approach (p.48)

## Appendices

- Impact of SAP 10.1 - Domestic example: impact on the mid-rise apartment building (p.50)
- Impact of SAP 10.1 - Non-domestic example: impact on the school (p.51)
- Energy and cost modelling assumptions (p. 52)

**Note:** this report and the carbon calculations underpinning its conclusions are based on the SAP 10.0 carbon content of electricity (233 gCO<sub>2</sub>/kWh). However, the conclusions and recommendations will not be affected by a change to the SAP 10.1 carbon content of electricity currently proposed (136 gCO<sub>2</sub>/kWh). This is demonstrated by the final section of this report.

# Thank you

This report is the result of a collaboration between five London boroughs and four consultants. We are very grateful to the following organisations and individuals for their contribution.



**Neil Pearce**, Commissioning Lead  
Energy & Sustainability



**Joanne Mortenson**, Climate Action Programme Manager  
**Ian Weake**, Principal Planning Officer



**Maria Yashchanka**, Principal Sustainability Officer  
**Karen Montgomerie**, Planning Policy Manager  
**Donna Skordili**, Energy and Sustainability Officer



**Joe Baker**, Head of Carbon Management  
**Suzanne Kimman**, Climate Change Officer  
**Tim Starley-Grainger**, Energy Infrastructure Manager  
**Bryce Tudball**, Planning Policy Team Manager



**Damian Hemmings**, Principal Policy Officer  
**Jo Gay**, Team Leader, Environment Policy & Projects  
**Kimberley Hopkins**, City and Planning Policy Team Leader



Clara Bagenal George  
Alkyoni Papisifaki  
Hugh Dugdale

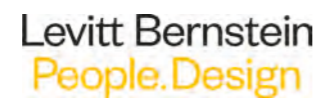

Clare Murray  
Zoe Watson



Adam MacTavish  
Jess Daly  
Tassos Kougonis



Naomi Grint  
Caitlin Brown  
Chris Worboys  
Ed Cremin  
Leon Tatlock  
Thomas Lefevre

# Executive summary | Incentivising greater savings on site with the carbon offset price

## There is a climate emergency

Climate change is happening at an alarming rate. A number of London boroughs have declared a climate emergency and need to reduce energy use and carbon emissions of new buildings. Evidence from the Committee on Climate Change also highlights the need to design and build buildings which are low carbon and use less energy in reality (not only at the planning/design stage).

## Phasing out natural gas and controlling heating costs

We also need to phase out the use of natural gas for heating new buildings. However, it is important to ensure that the transition towards low carbon heat (e.g. heat pumps, low carbon heat networks) does not lead to high heating costs. The reduction of heating demand and the affordability of heat for occupants should become a greater concern.

## The issue with the current carbon price

The current carbon offset price (£60-£95/tCO<sub>2</sub>) and requirement of a minimum 35% carbon reduction\* do not incentivise sufficient savings on site. This means that new buildings have substantially higher carbon emissions than they should.

In addition, our analysis suggests that the current carbon offset price is not sufficient for local authorities to deliver the required carbon savings off-site. A price of at least £300/tCO<sub>2</sub> is recommended to enable them to deliver these carbon savings.

## A new carbon price: our recommendations

We have undertaken extensive energy modelling on several typologies of buildings. Our calculations demonstrate that the decarbonisation of the electricity grid means that, for the same specifications, a greater improvement over Part L is achieved with no extra effort/cost ('60% is the new 35%'). On this basis, and given the consensus on the need and benefit of a 'fabric first' approach and low carbon heat, our recommendations are:

- To incentivise on-site savings by adopting a **high first tier price of £1,000/tCO<sub>2</sub>** for those easily avoidable and unnecessary residual emissions not met on-site, which fall short of a 60% improvement threshold (measured over Part L1A) for domestic and a 50% improvement threshold (measured over Part L2A) for non-domestic developments.
- To incentive PVs\*\* with the introduction of a **medium carbon price second tier of £300/tCO<sub>2</sub>**.
- Finally, and **only for residential applications** for which it is easier to achieve this high level of performance than for non-residential applications, we recommend a **low carbon price third tier of £100/tCO<sub>2</sub>** as a positive signal.

\* The carbon reduction is calculated by comparing the proposed building carbon emissions to those of an equivalent 'notional' building using standard assumptions.

\*\* Our analysis suggests that with 233 gCO<sub>2</sub>/kWh (SAP 10.0) the savings from the use of PVs are equivalent to a carbon cost ratio of around £190/tCO<sub>2</sub>.

Significant improvements over Part L (using SAP 10.0 carbon factors) can be achieved now with efficient fabric, ventilation as well as low carbon heat.

Reduction in CO <sub>2</sub> - SAP 10.0 (reg)		With PV			
		Gas boiler	Direct electric	Heat pump	Better heat pump
Fabric & Ventilation	Business as usual	26%	40%	71%	87%
	Good practice	36%	51%	77%	91%
	Ultra-low energy	51%	66%	86%	96%

Table 1 - Example for a typical **medium-rise apartment building**. It demonstrates that it is justified to penalise the band of emissions worse than a 60% improvement and that improvements in excess of 80% are possible and should be encouraged.

Reduction in CO <sub>2</sub> - SAP 10.0 (reg)		With PV			
		Gas boiler	VRF	Heat pump	Better heat pump
Fabric & Ventilation	Business as usual	29%	48%	44%	49%
	Good practice	41%	54%	51%	55%
	Ultra-low energy	55%	61%	59%	61%

Table 2 - Example for a typical **new office building**. It demonstrates that it is justified to penalise the band of emissions worse than a 50% improvement and that improvements in excess of 80% are not easy to achieve based on the current Part L methodology (they rely entirely on the roof areas available for PVs).

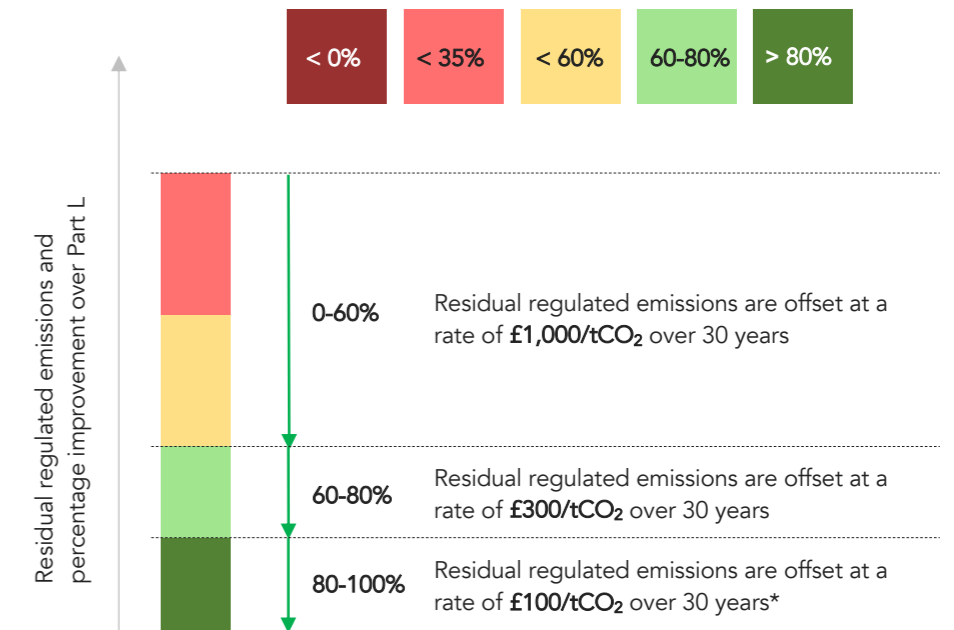

Figure 1 - Recommended tiered carbon prices for **domestic buildings**. The third tier aims at sending a positive signal that this level of Part L performance is achievable today.

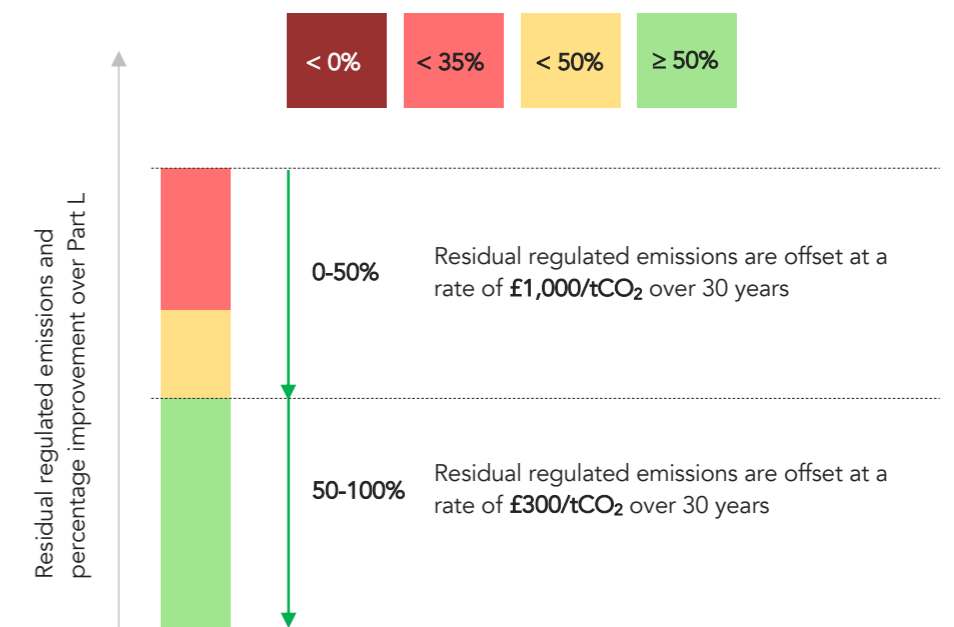

Figure 2 - Recommended tiered carbon prices for **non-domestic buildings**. There is no third tier due to the limitations of Part L/SBEM for non-domestic buildings which make it more challenging to achieve an 80% improvement for all typologies.



# Executive summary | A modest impact on viability

## Construction costs of lower carbon buildings

The uplift costs associated with each specification option were estimated for each typology based on Currie & Brown's cost datasets for energy efficiency and low carbon technologies which incorporate information from market prices obtained, specific market testing and first principles cost planning by their specialist quantity surveyors. The costs are based on Q3 2019 prices and reflect a London / South East cost base.

For example, for the **medium-rise apartment**, the baseline in terms of construction costs is the 'Business as usual fabric and ventilation + Gas boiler + PVs' scenario. This scenario is nearly compliant with the London Plan requirement of a minimum 35% carbon reduction over Part L (i.e. 26%). The additional construction costs of lowest carbon options compared to this baseline are comprised between 0.4% and 6.8%. They capture savings associated with combining an ultra-low energy fabric, ventilation system and a low carbon heating system. They do not highlight the cost reductions which can be achieved with a low energy design process (e.g. form factor).

## Impact on development costs

The potential impact on total development cost was estimated on the basis of the construction cost representing c.40% of the total development costs with the balance being comprised of land cost, finance and project fees and other planning requirements. For example, for the **medium-rise apartment**, it means that the impact would therefore be only between 0.2% and 2.7% if the whole development costs were considered.

## Impact on viability

Example for the medium-rise apartment building:

- Based on the current approach with a **flat carbon price at £60/t**, the **baseline scenario in terms of construction costs** ('Business as usual + Gas boiler + PVs') would be required to make a carbon offsetting contribution equivalent to approximately **£20/m<sup>2</sup>**.
- Based on the **proposed new tiered carbon price**, the most economic **low carbon scenarios** in terms of combined additional construction costs and carbon offsetting costs would represent an additional cost comprised between **£18-£69/m<sup>2</sup> compared to the baseline**.

The additional cost range is provided on the adjacent table.

## It is worth the additional cost

Delivering better quality buildings which put us on the right track towards 2025 and 2030 is essential. Although it will cost more, we do not think that this would significantly affect viability, while contributing significantly to key policy objectives: air quality, fuel poverty, reduced running costs and addressing the climate emergency.

Reduction in CO <sub>2</sub> - SAP 10.0 (reg)		With PV			
		Gas boiler	Direct electric	Heat pump	Better heat pump
Fabric & Ventilation	Business as usual	28%	40%	71%	87%
	Good practice	38%	51%	77%	91%
	Ultra-low energy	51%	66%	86%	96%

Table 3 - Example for a typical **medium-rise apartment building**. Improvement over Part L assuming 233 gCO<sub>2</sub>/kWh (SAP 10) for grid-supplied electricity

Additional costs of the most economic low carbon scenarios with the proposed new carbon prices (compared with the baseline scenario and a carbon price of £60/t)	
Terrace house	+£8-23/m <sup>2</sup>
Medium-rise apartment building	+£18-69/m <sup>2</sup>
High-rise apartment building	+£79-85/m <sup>2</sup>
Hotel	-£22/m <sup>2</sup>
School	+£62/m <sup>2</sup>
Office building	+£71/m <sup>2</sup>

Table 5 - Impact of the new proposed approach to carbon offset price on the total construction cost + carbon offsetting cost of the most economic low carbon scenarios compared with the respective baselines (Business as Usual fabric and ventilation + Direct electric or VRF + PVs)

This analysis is based on a carbon price of £60/tCO<sub>2</sub> and the SAP 10.0 carbon factor. If the current carbon price recommended by the GLA was to be used (£95t/tCO<sub>2</sub>) with the current Part L 2013 carbon factor, the impact on costs above would be smaller. It can therefore be considered a conservative estimate.

## Mid-rise apartment (~ £2,200/m<sup>2</sup> baseline construction cost)

% uplift in cost per m <sup>2</sup> of construction		With PV			
		Gas boiler	Direct electric	Heat pump	Better heat pump
Fabric & Ventilation	Business as usual	0.6%	-2.7%	1.6%	3.7%
	Good practice	1.8%	-0.9%	3.4%	5.5%
	Ultra-low energy	3.1%	0.4%	4.7%	6.8%

Table 4 - **Mid-rise apartment building** - Additional construction costs (£/m<sup>2</sup>) compared with the 'Business as usual + Gas boiler scenario + PVs' baseline scenario - Analysis by Currie & Brown

Does it incentivise?	Current carbon price	Proposed new carbon price
Greater carbon savings on-site?	✗	✓
Greater energy use reduction?	✗	✓
Best practice (e.g. Passivhaus)?	✗	~
Low carbon heat?	~	✓
Low impact on air quality	~	✓
More PVs on site?	✗	✓

Table 6 - Comparison of the current and proposed carbon offset prices in terms of potential impact

# Executive summary | Towards Net Zero Carbon buildings: a better approach is needed

## There are bigger issues with the current system

Carbon pricing can help to incentivise greater savings on site if the current approach based on Part L modelling continues to be used but our recommendation is to move towards a better system to address the following issues:

- **Relative metric:** the percentage improvement against a notional building is confusing and misleading. It also does not reward efficient designs/forms.
- **Carbon only:** using carbon only metrics gives the carbon factors a pivotal role. When the carbon factor used in the building regulations is as outdated as it is now it can lead to the wrong outcomes.
- **Tools not fit for purpose:** Part L was never meant to be used to predict energy use but it is being used for this. This contradiction has been accepted for too long. The inaccuracy of Part L modelling for non-domestic buildings at predicting heating demand is particularly concerning. This means that an improved building fabric is not incentivised.
- **Not Net Zero Carbon:** a building which achieves a 100% improvement over Part L is not a Net Zero Carbon building.

## Next steps: our recommendations for a better, simpler system towards Net Zero

We therefore recommend to introduce the following changes to the system now in order to set planning requirements on the right path towards Net Zero Carbon, and to step up the requirements over time.

1. **Introduce Energy Use Intensity (EUI) requirements:** the use of maximum EUIs based on absolute values (e.g. 60kWh/m<sup>2</sup>/yr for residential from now, reducing to 35kWh/m<sup>2</sup>/yr from 2025) would help as it is an absolute metric, is independent from carbon and can be easily verified by the building/home owner/tenant after completion.
2. **Request the prediction of energy use modelling:** We recommend to make the estimate of the building's future energy use mandatory. This could be done with PHPP (Passivhaus Planning Package) and/or other tools consistent with the CIBSE TM54 methodology which are more accurate and were designed for this purpose.
3. **Consider regulated and unregulated energy:** unregulated energy needs to be assessed in addition to regulated energy if Net Zero Carbon building is the destination.
4. **Include planning conditions to address the performance gap:** more energy modelling and quality checks after planning, particularly during detailed design and construction would help to reduce the performance gap.

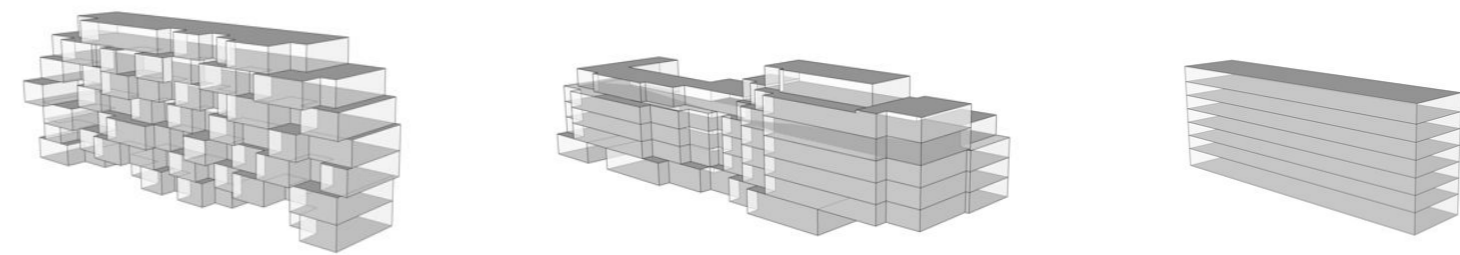

### Form factor

(ratio between external envelope area and internal floor areas)

1.5

1.2

0.9

### Improvement over Part L 2013

(assuming good practice specifications)

-35%

-35%

-37%

Figure 3 - Despite the reduction in heat loss areas and complexity, the percentage improvement over Part L does not vary much between the designs above. This shows that a relative metric is not as useful and clear as an absolute metric for energy efficiency.

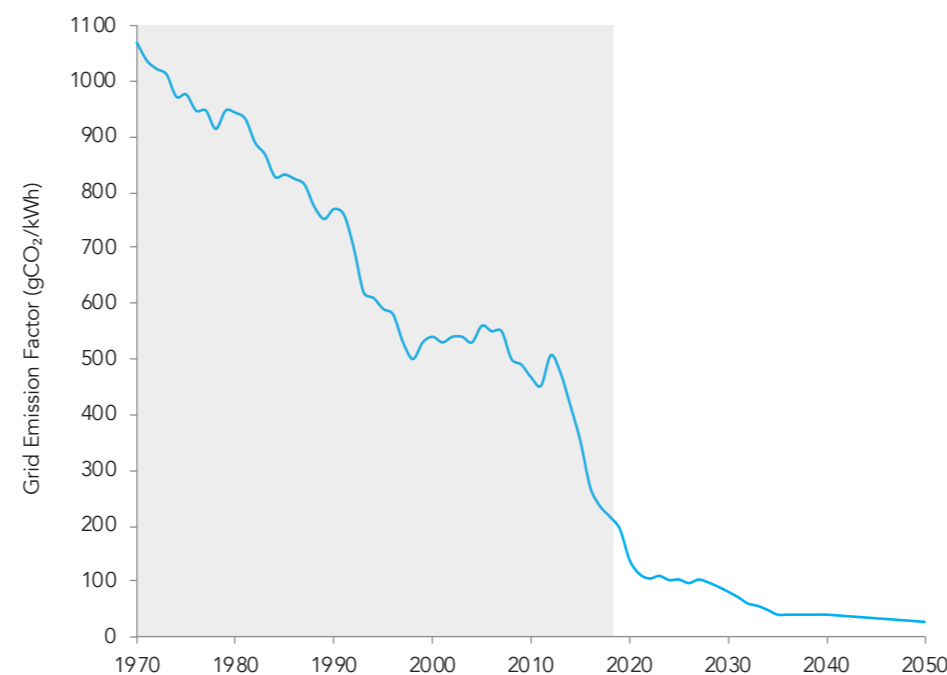
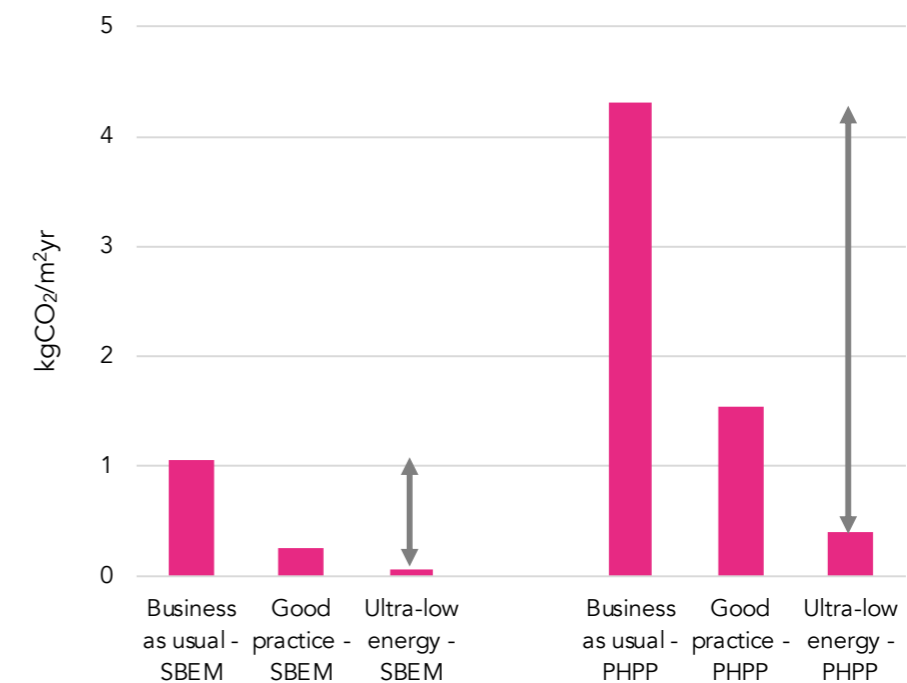

Figure 4 - The electricity grid will continue to decarbonise in the next few years. Using an absolute energy metric would bring clarity toward better energy efficiency as it would be independent from the grid electricity carbon factor.



x4 reduction in heating carbon emissions due to ultra low energy fabric compared with Business as usual fabric

Figure 5 - CO<sub>2</sub> emissions associated with space heating for the School as assessed by Part L/SBEM (left hand side) and predicted energy use modelling/PHPP (right hand side) As Part L2A assessments underestimate space heating requirements, they also underestimate carbon savings achieved as a result of fabric and ventilation improvements



# Section 1

## The climate emergency: Impact on new buildings in London

---

- There is a climate emergency
- Reducing energy use in new buildings
- The low carbon electricity revolution
- What is low carbon heat?
- Fuel poverty
- Towards Net Zero Carbon buildings





## The science is clear

Climate change is happening and needs to be urgently slowed down to avoid terrible consequences.

The most recent international negotiations on Climate Change concluded with the Paris Agreement in December 2015. Since then, the Special Report on Global Warming of 1.5°C (SR15) was published by the Intergovernmental Panel on Climate Change (IPCC) in October 2018 and highlighted the urgency of the situation. We need to act now.

## National commitment

In May 2019, the Committee on Climate Change published its 'Net Zero report' and set out the ambitious aim of phasing out carbon emissions in the UK by 2050. The Government adopted the recommendation of this report and the Climate Change Act was amended in June 2019 to reflect this ambition: achieving net zero emissions by 2050.

## Public calls for action

Since October 2018, there has been a surge in civil society's interest and action on climate change. The Schools strike movement started by Greta Thunberg and civil disobedience from Extinction Rebellion are requesting action and truth from those in a position to act.

## London Boroughs' declarations of climate emergency

All five London Boroughs who have directed this study have already declared a climate emergency and set a target to achieve Net Zero Carbon as a whole borough.

Most of them expect policy to require Net Zero Carbon buildings in the short to medium term.

The role of local authorities towards Net Zero Carbon cannot be understated. Setting targets, developing action plans, showing leadership, sharing expertise, monitoring progress: they have a crucial role to play.

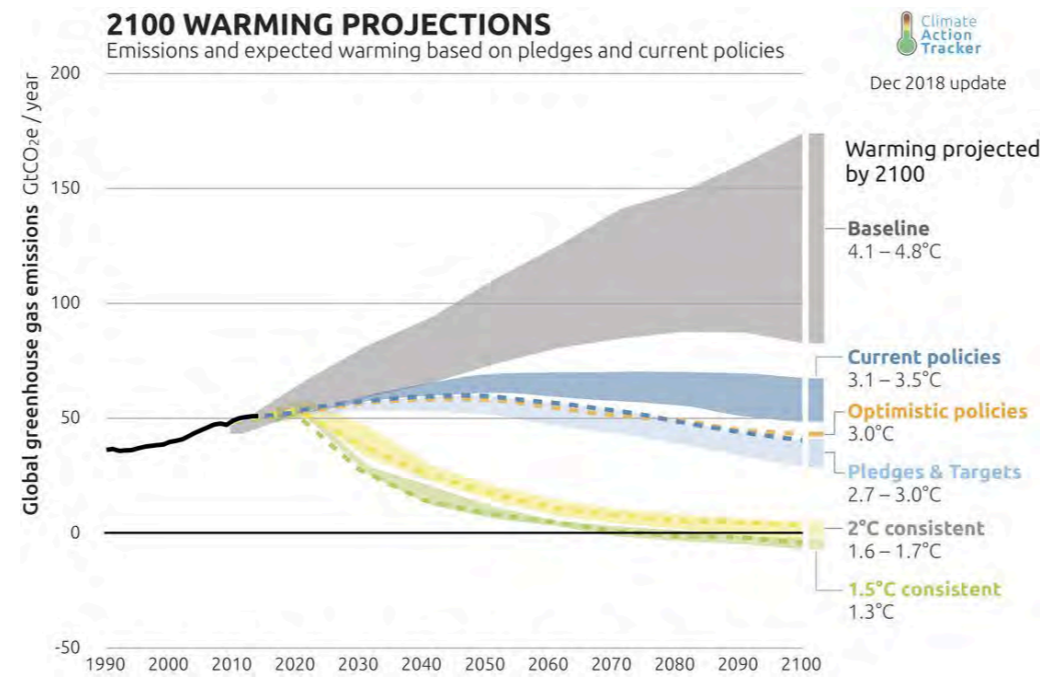

Figure 6 - We have to do everything we can to reduce global warming to less than 1.5°C

	Barking & Dagenham	Ealing	Haringey	Greenwich	WCC
Declaration of climate emergency?	✓	✓	✓	✓	✓
Net Zero Carbon target (Council)	2030	2030	-	2030	2030
Net Zero Carbon target (Whole borough)	2030	2030	2041	2030	2040
Action plan?	-	within 8 months	✓	within 8 months	within 6 months
Policy for Net Zero Carbon buildings in operation?	< 2 years (new homes)	< 2 years	-	< 2 years (new homes)	Not before 2025

Table 7 - Table showing which local authorities have declared a climate emergency



Figure 7 - The UK Government has committed in June 2019 to Net Zero emissions by 2050



Figure 8 - Greta Thunberg, the Schools strike movement and Extinction Rebellion are calling for action now



## Reducing energy use is critical

Energy efficiency has always been the first step in the energy hierarchy and needs to remain the priority. It is not only important to reduce carbon emissions in the short term: we should not build buildings now which will need to be retrofitted in 15 years.

The wider benefits of energy efficiency are also perceived now, and their role to minimise peak demand is very important.

## Buildings Energy Mission: reducing energy use in new buildings by 50%

The Department for Business, Energy and Industrial Strategy (BEIS) has set the Buildings Energy Mission, with the objective of halving the energy use of new buildings by 2030.

The Department for Business, Energy & Industrial Strategy (BEIS) asked the Green Construction Board to respond to the 2030 Buildings Energy Mission. The background report published as part of this response reviewed the evidence from buildings which have already achieved a 50% reduction in energy use. There is a lot which can be learnt from these buildings as there are recurring approaches, techniques and systems that are responsible for their excellent energy efficiency. These are summarised on the adjacent figure.



Figure 9 - Recurring features of a low energy building

## The future of housing

The Committee on Climate Change has published a report in 2019 named 'UK housing – fit for the future?'. The report highlights the need to build new buildings with 'ultra-low' levels of energy use. It also makes a specific reference to space heating demand and recommends a maximum of 15-20 kWh/m<sup>2</sup>/yr for new dwellings. For reference, Passivhaus requires 15 kWh/m<sup>2</sup>/yr and most new domestic buildings have a heating demand of 40-80 kWh/m<sup>2</sup>/yr.

## The cost of changing from 'business as usual' to ultra low energy

The technical study undertaken by Currie & Brown and AECOM for the Committee on Climate Change's *UK housing: Fit for the future?* report illustrates that a switch to low carbon heating is essential in achieving long term carbon savings, but that this must be supported by significant improvements in energy efficiency in order to manage running costs and avoid external costs to the wider energy system.

The study indicates that significant reductions in space heating demand can be achieved at lower cost than smaller improvements where steps are taken to achieve savings in the size and extent of the heating system.

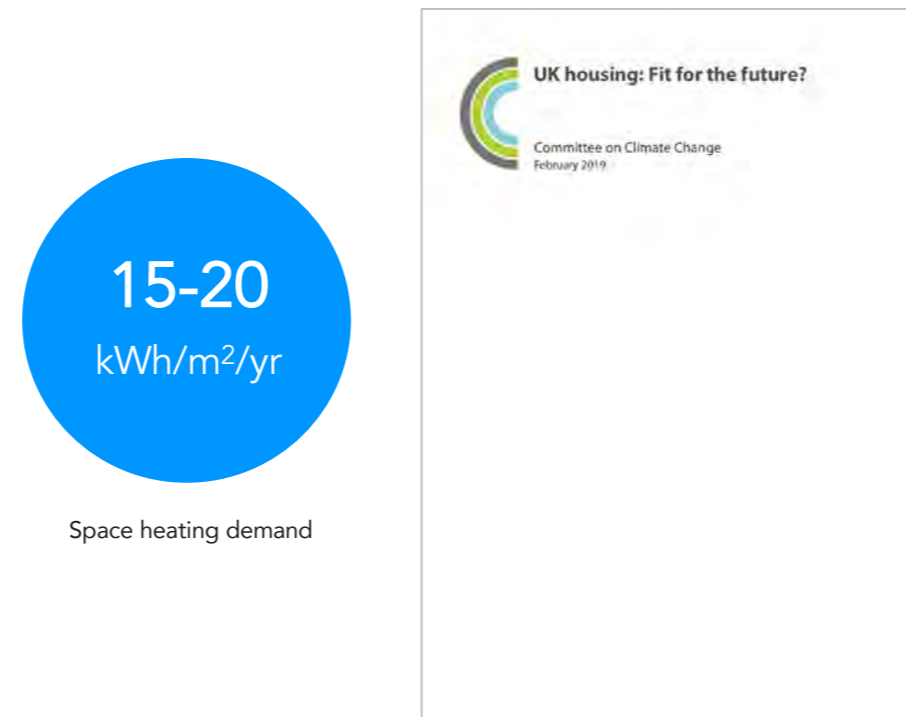

Figure 11 - *The UK housing: Fit for the future?* report published by the Committee of Climate Change in February 2019 recommends ultra-low levels of energy use and a space heating demand of less than 15-20 kWh/m<sup>2</sup>/yr



Figure 10 - Cover of the *Green Construction Board's Buildings Energy Mission 2030* report

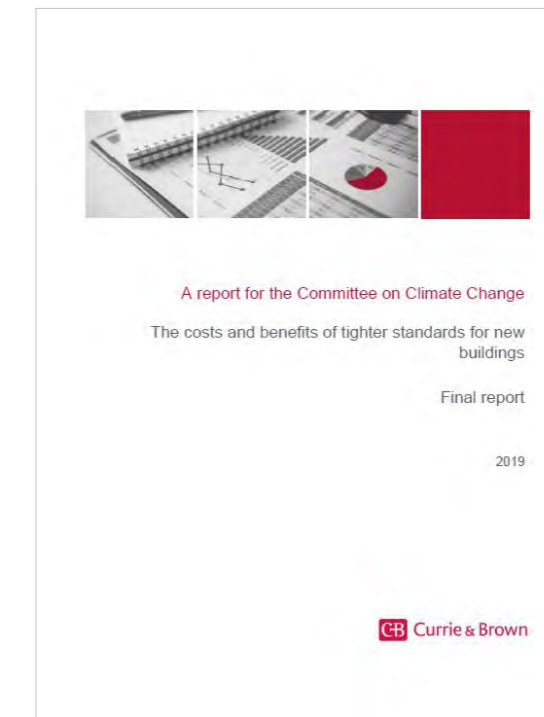

Figure 12 - *The costs and benefits of tighter standards for new buildings* report, produced by Currie & Brown and AECOM for the Committee on Climate Change's *UK housing: Fit for the future?* report

## The decarbonisation of the grid

Electricity used to have a very high carbon content: more than 1,000 gCO<sub>2</sub>/kWh in the early 1970's. It has become steadily 'greener' since, although it reached a plateau of approximately 500 gCO<sub>2</sub>/kWh during the 2000's. At that time, heating systems using gas were seen as environmentally friendly options. This has now changed completely: with the decommissioning of coal-fired power stations and the rise of renewable energy (particularly wind and solar), the annual average carbon content of electricity is now around 150-200 gCO<sub>2</sub>/kWh and predicted to reduce more in the next decade (see adjacent graph).

## The National Grid's Future Energy Scenarios

The National Grid produces a set of future energy scenarios every year. These are used to facilitate the understanding of how the UK's electricity generation mix could develop. We have selected the 'Community Renewables' scenario as it would meet (or be close to meeting) the UK climate change targets with less nuclear energy than other scenarios (there is a significant degree of uncertainty for new nuclear plant financing). This scenario assumes that around 70% of annual electricity demand in 2050 will be met by wind and solar power. BEIS and HM Treasury have also published their projections for the future carbon content of electricity, which converge with the 'Community Renewables' scenario..

## What it means in practice

The average carbon content of electricity was 189 gCO<sub>2</sub>/kWh in 2019, and is likely to be 123 gCO<sub>2</sub>/kWh in 2020, 60 gCO<sub>2</sub>/kWh in 2030 and 30 gCO<sub>2</sub>/kWh in 2050, while gas is likely to remain at around 200 gCO<sub>2</sub>/kWh.

The marginal carbon content of electricity is higher and is also reducing at a slower rate. It is approximately 300 gCO<sub>2</sub>/kWh currently and is schedule to reach 200 gCO<sub>2</sub>/kWh in 2027 and less than 100 gCO<sub>2</sub>/kWh in the early 2030s. It is converging towards the same value as the average carbon content in 2040.

## A 'greener' and 'smarter' grid

Such a decarbonisation of the grid will only happen if the majority of annual electricity demand in 2050 will be met by wind and solar power. This considerable level of renewable energy (shown on the adjacent graph) can be achieved if the current levels of solar photovoltaic (PVs) are significantly increased: every new building should have an optimised PV system. The grid will also have to be 'smarter' with a much more dynamic 'demand response' system. This will rely on buildings being able to shift their power demand to help the electricity grid. This will also help to reduce peak demand and therefore to help control the cost of electricity.

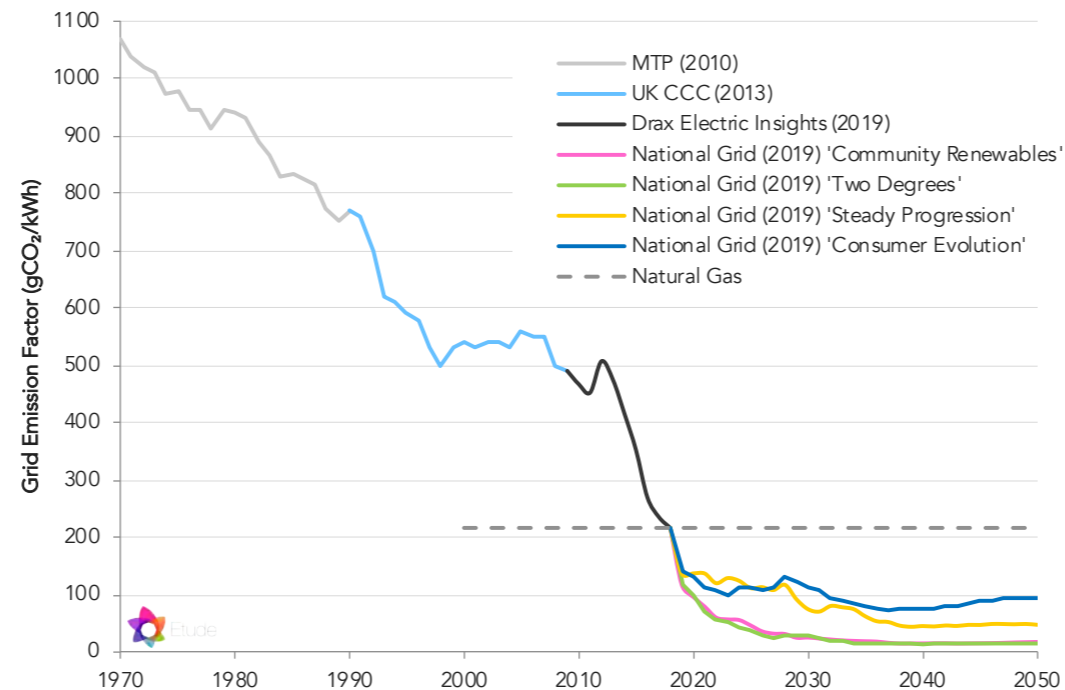

Figure 13 - The carbon content of electricity has fallen in the last few years and will continue to decrease. Unfortunately, the carbon content used in Part L 2013 of the Building Regulations has not been updated.

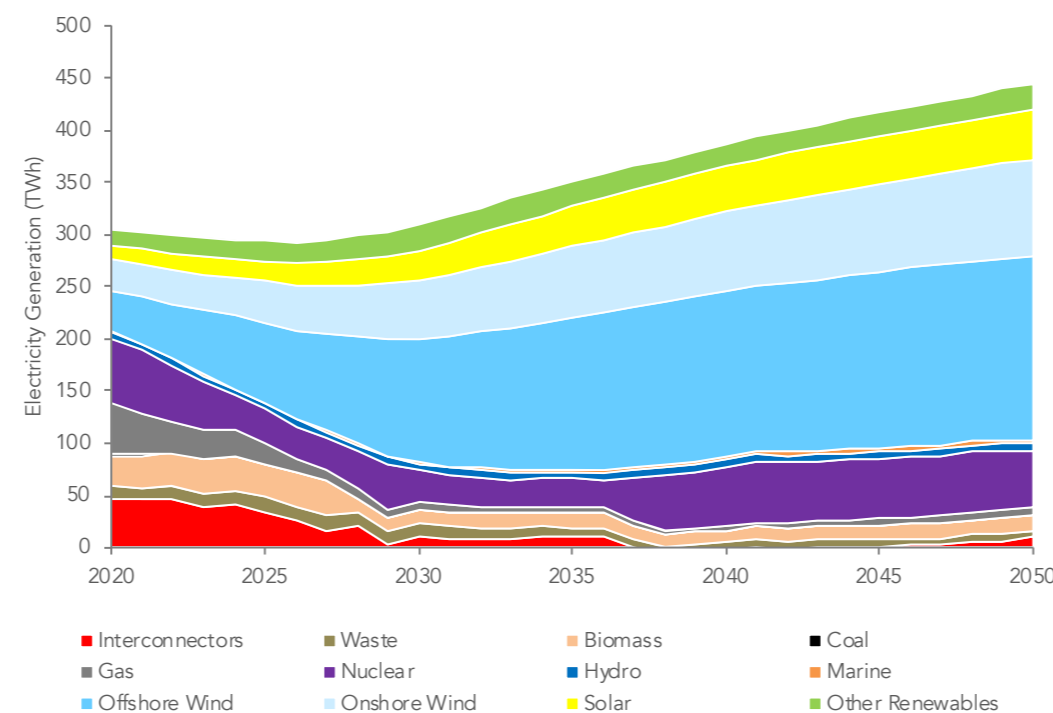

Figure 15 - Community Renewables: what it means in terms of power generation in the UK over the period 2020-2050: the rise of renewable energy

'Consumer Evolution'	Discounted Not compliant with avoiding 1.5°C warming
'Steady Progression'	Discounted Not compliant with avoiding 1.5°C warming
'Two Degrees'	Discounted Relies on nuclear capacity increasing from 9GW in 2018 to 17GW in 2050. Not considered realistic as three of six proposed new nuclear projects have been cancelled, nuclear has consistently failed to attract private investment and electricity prices are higher than those for onshore wind, offshore wind and solar photovoltaics.
'Community Renewables'	Considered Etude assume this scenario offers the most plausible 1.5°C compliant UK electricity generation mix pathway. This scenario was developed to achieve the UK's now outdated Climate Change Act target of an 80% reduction in emissions by 2050.

Figure 14 - High level assessment of the four National Grid scenarios



Figure 16 - Roof-mounted PV installations will have to be maximised. The panels selected should be high output and the concertina arrangement makes the most of the roof space available



## A paradigm shift

As the electricity grid is decarbonising, heating systems using electricity (e.g. heat pumps) become lower carbon heating solutions than those using fossil fuels (e.g. natural gas). This is also true of systems using fossil fuels to generate on-site electricity which will become high carbon heating systems as the margins of the grid decarbonise.

There is also a consensus that fossil fuels must be phased out by 2050 and it is much easier to achieve this in the building sector than in others (e.g. industry, aviation). It is therefore justified to prevent or at least disincentivise the use of fossil fuels for heating and hot water in new buildings. This is also in line with the Committee on Climate Change recommendation that 'from 2025 at the latest, no new homes should be connected to the gas grid, with ultra-low energy houses and flats using low carbon heat instead'. Locking in the use of fossil fuels for the medium to long terms must be avoided.

## Electrification of heat

We consider that the electrification of heat is the most likely scenario in the future for buildings. Along with becoming a lower carbon energy source, electricity has other advantages, particularly in terms of local air quality, a concern in London.

Peak demand can be reduced to ensure pressure is not unduly put on the electricity grid. This can be done by:

1. reducing heat demand using efficient building fabric and ventilation systems.
2. reducing electrical demand by using a technology which is more efficient than direct electric heating: heat pumps.
3. managing heat demand so that it can enable a smart grid.

## Heat networks with waste heat

Alongside heat networks supplied by heat pumps, there is a role for low carbon low temperature waste heat networks. There are different sources of waste heat which could be used, from tube vent shafts and reservoirs to waste heat from industrial processes. The carbon content of this heat, distribution losses and the sustainability of the waste heat source should be evaluated.

## How we modelled different heating systems

We modelled four different levels of carbon content of heat (assuming SAP 10.0) and provided for each of them an example of a system which should be able to achieve it (see Figure 19).

## Hydrogen is not a likely option for London

Our analysis concluded that hydrogen is unlikely to play a significant role in London as other uses (e.g. industrial heat, top up heating for some buildings on very cold days, back-up power generation and heavy-duty vehicles) would be more appropriate.

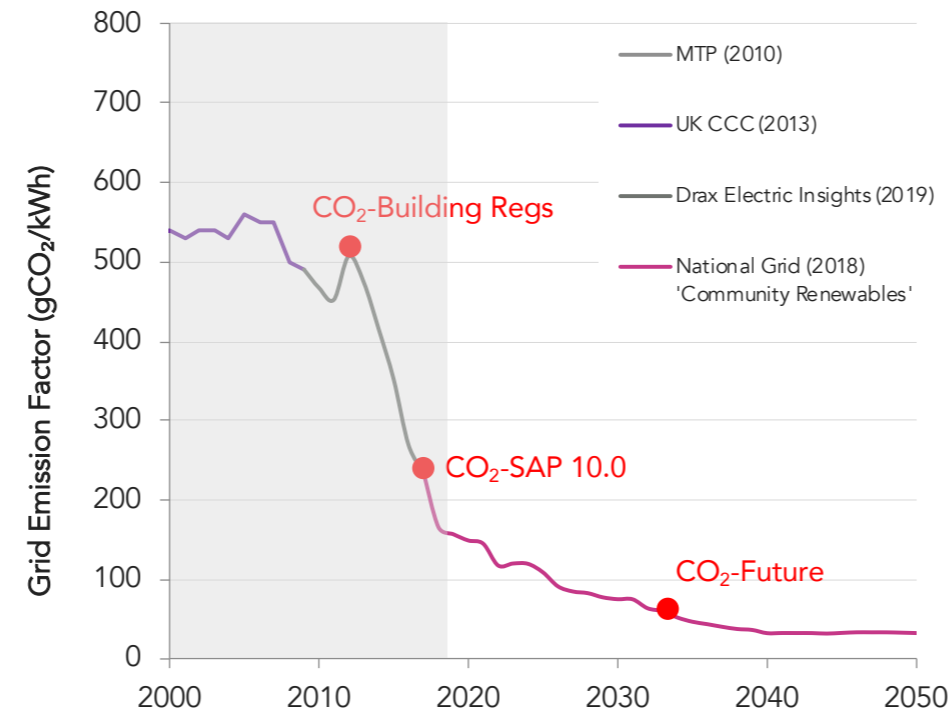

Figure 17 - Evolution of the carbon content of grid-supplied electricity. The marginal carbon content of electricity is also reducing towards the same value in 2040 but at a slower rate.

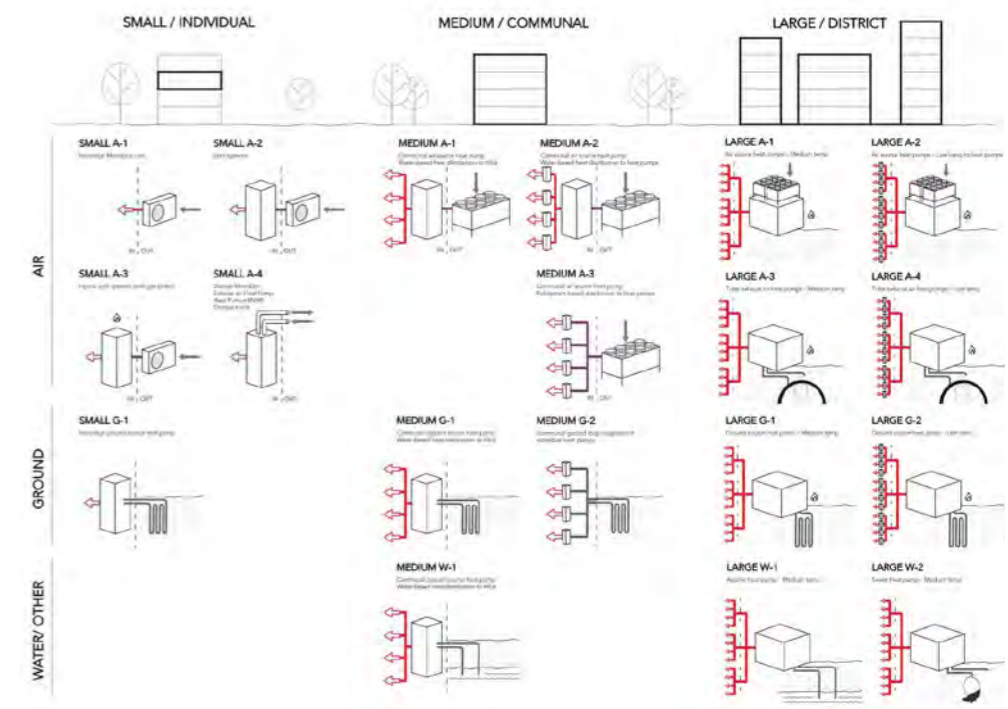

Figure 18 - Heat pumps are available in many different types and scales, from individual systems to heat pumps supplying heat networks (© Etude for the Greater London Authority)

Heating system	Carbon emission band*			
	High carbon			Low carbon
Carbon emission band*	> 250 gCO <sub>2</sub> /kWh	200-250 gCO <sub>2</sub> /kWh	100-200 gCO <sub>2</sub> /kWh	< 100 gCO <sub>2</sub> /kWh
Example heating system	A. Gas boiler	B. Direct electric	C. Heat pump	D. Better heat pump

\* assuming SAP 10.0 carbon factors)

Figure 19 - Approximate carbon emission band of heating system modelled

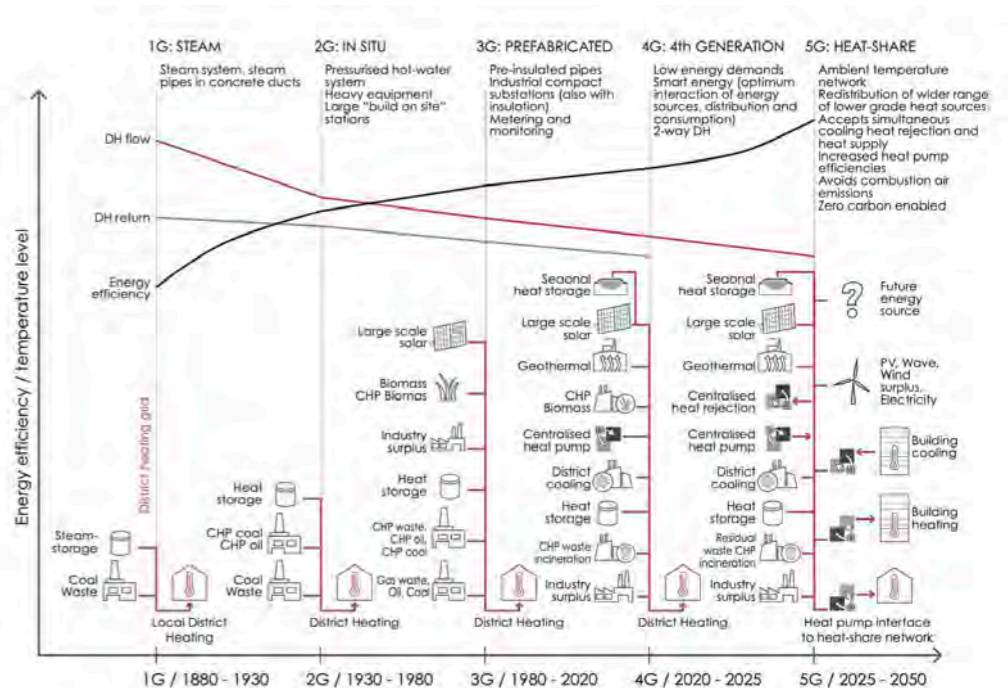

Figure 20 - Summary of evolution of heat networks towards lower temperatures and lower carbon sources (Source: Chris Twinn for LETI's Climate Emergency Design Guide)

## Fuel poverty in London

Fuel poverty in England is measured using the Low Income High Costs (LIHC) indicator. Under this indicator, a household is considered to be fuel poor if they have required fuel costs that are above average and, if they were to spend that amount, if they would be left with a residual income below the official poverty line.

The main drivers of fuel poverty are the household income, its energy requirements and the energy prices. A number of mechanisms seek to alleviate fuel poverty through requirements on utility companies or financial assistance (e.g. warm home discount).

According to the sub-regional fuel poverty statistics, 11.8% of households in London (i.e. 397,924 households out of a total of 3,371,821) are fuel poor<sup>1</sup>. However, it is not currently directly addressed by energy planning policies in London. The considerations below explore what could be done with the buildings themselves and therefore through the planning system.

## Low carbon new homes must be affordable to run

Historically, carbon has been considered as the exclusive proxy for the energy costs but some systems could be low carbon and lead to high energy bills (e.g. direct electric heating in a 'business as usual' building in London). It is therefore important that the implications of design decisions in terms of energy costs are better considered by applicants. In order to mitigate any risk of fuel poverty or issues with affordability, applicants should be required to demonstrate how they will ensure a best practice level of energy efficiency (e.g. Passivhaus) and/or how they will include systems which are more energy efficient than direct electric heating (e.g. heat pumps) and ensure that they are economic to run.

Assessing future annual energy costs at planning stage (including all components of the adjacent figure) could help. This would be particularly useful for Council-led schemes and affordable housing units.

<sup>1</sup> Household and fuel poverty numbers at region level come from the national fuel poverty statistics, 2017: <https://www.gov.uk/government/statistics/fuel-poverty-detailed-tables-2019>

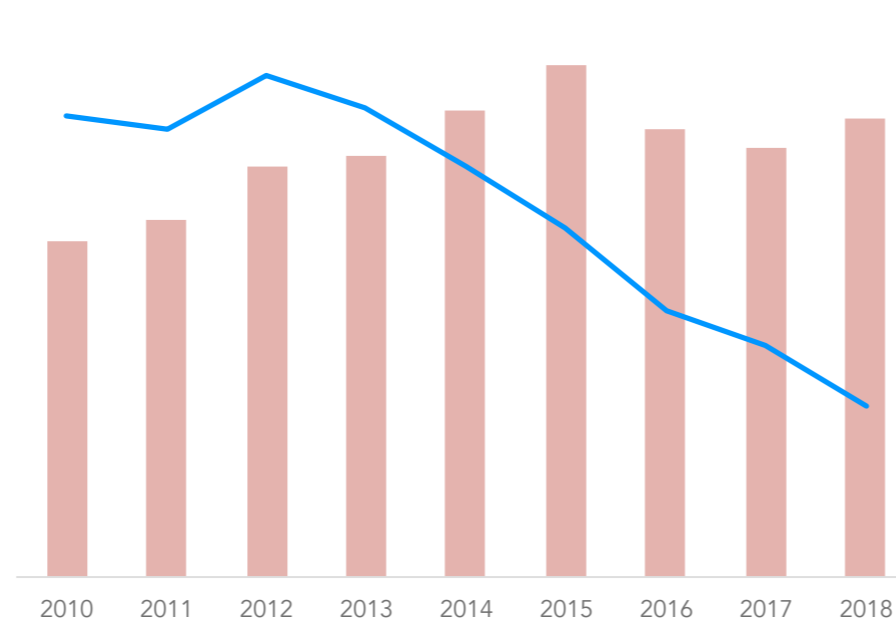

Figure 25 - Compared evolution of the carbon content of electricity (blue line) and the average price of electricity for domestic consumers (red bars) over the last 10 years.

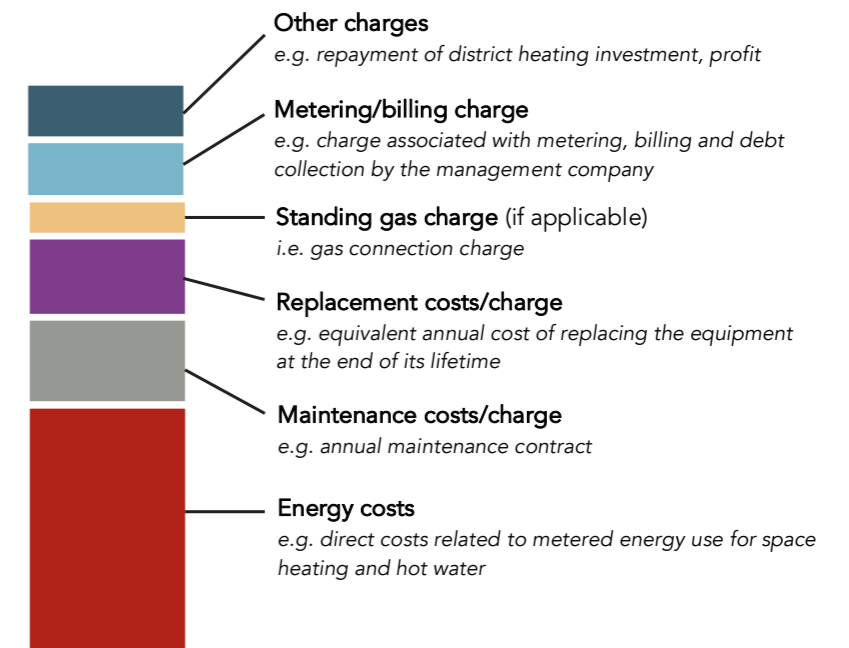

Figure 26 - The different components of energy costs. Energy costs generally form the main part of residents heating costs, but they could be responsible, directly or indirectly, for other costs which should be included.

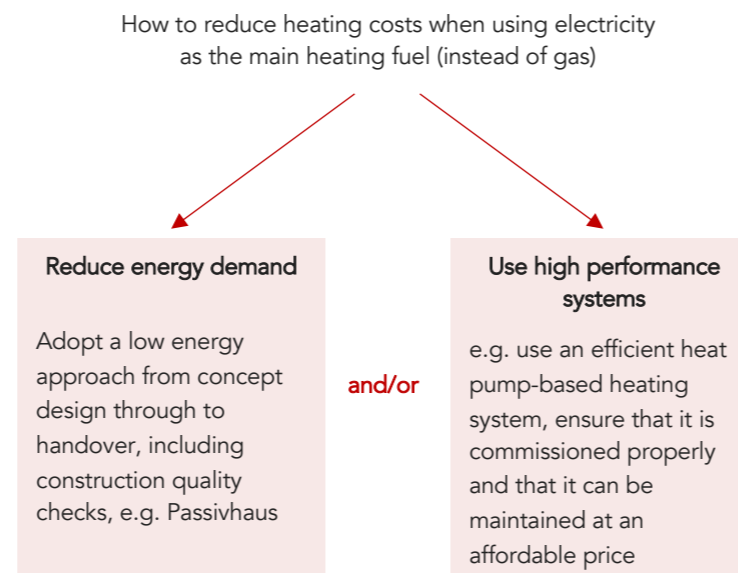

Figure 27 - Available approaches to minimise heating costs when using electricity (which is expensive) as the main heating fuel



## What Zero Carbon roadmaps tell us

More than 200 local authorities in the UK have declared a climate emergency and a growing number of them are developing science-based targets, a Zero Carbon Roadmap and the associated action plan. These highlight two conclusions relevant to this study:

- the limited role for offsetting in the long term.
- the need for new buildings to reduce on-site emissions to a fraction of what they are now, and to become ideally Net Zero or even Net Positive buildings.

These Zero Carbon roadmaps are likely to significantly influence the requirements for new buildings in London.

## Net Zero Carbon Policy in London

Policy SI2 *Minimising greenhouse gas emissions* in the new London Plan states that **all major developments should be net zero-carbon**. This provides a strong policy basis for all boroughs. It also includes specific requirements in terms of energy efficiency ('be lean'), embodied carbon calculation and energy data disclosure.

Unfortunately the current interpretation of this policy is not consistent with the policy ambition: developments tend to achieve a minimum 35% reduction in on-site regulated carbon emissions and offset only the residual regulated emissions.

## The definition of a Net Zero Carbon building

A lot of work has recently been undertaken in that area in the last 18 months internationally and in the UK to define Net Zero Carbon. The UKGBC have published their framework in April 2019 and have worked with LETI on the development of a simple definition for Net Zero Carbon new buildings (in operation), now supported by the BBP, the Good Homes Alliance, RIBA and CIBSE. The requirements highlight the importance of all elements below:

- Low energy use
- Low carbon energy supply
- Measurement and verification
- Zero carbon balance (i.e. 100% of the energy used is produced – on-site or off-site – by renewable energy)
- Embodied carbon

## A specific role for offsetting

In the future, offsetting should only be allowed when every reasonable effort has been made to minimise energy use, use low carbon heat and integrate PVs. Therefore unless carbon offsetting becomes so expensive that Net Zero Carbon buildings are more commercially attractive, other mechanisms are likely to be required to make Zero Carbon a reality.

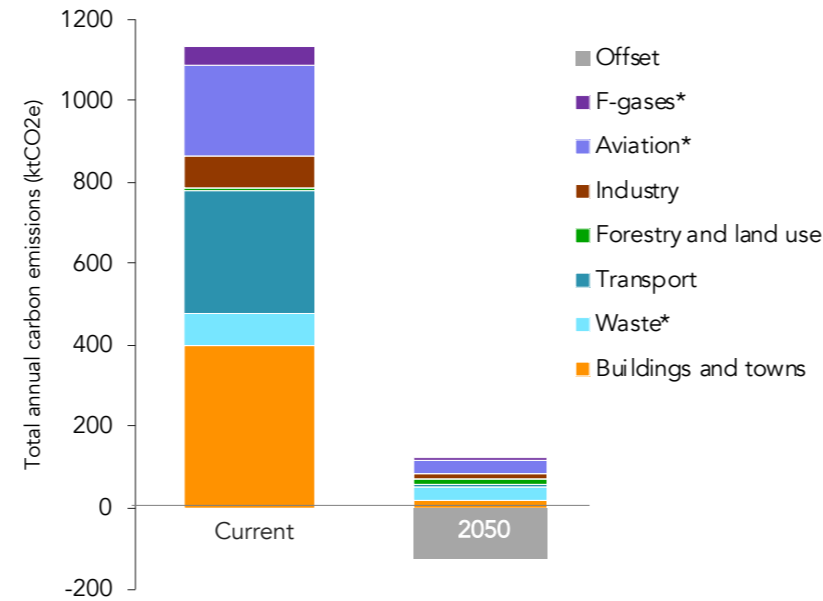

Figure 28 - Current greenhouse gas emissions vs target emissions in 2050 for a local authority. GHG emissions associated with buildings (new and existing) will have to reduce to near zero.



Figure 30 - Current initiatives aimed at defining Net Zero Carbon buildings: The UKGBC Framework (2019)



Figure 29 - Manchester have developed a framework to become Net Zero Carbon by 2038. This includes a requirement for all new buildings to be Net Zero Carbon by 2028.

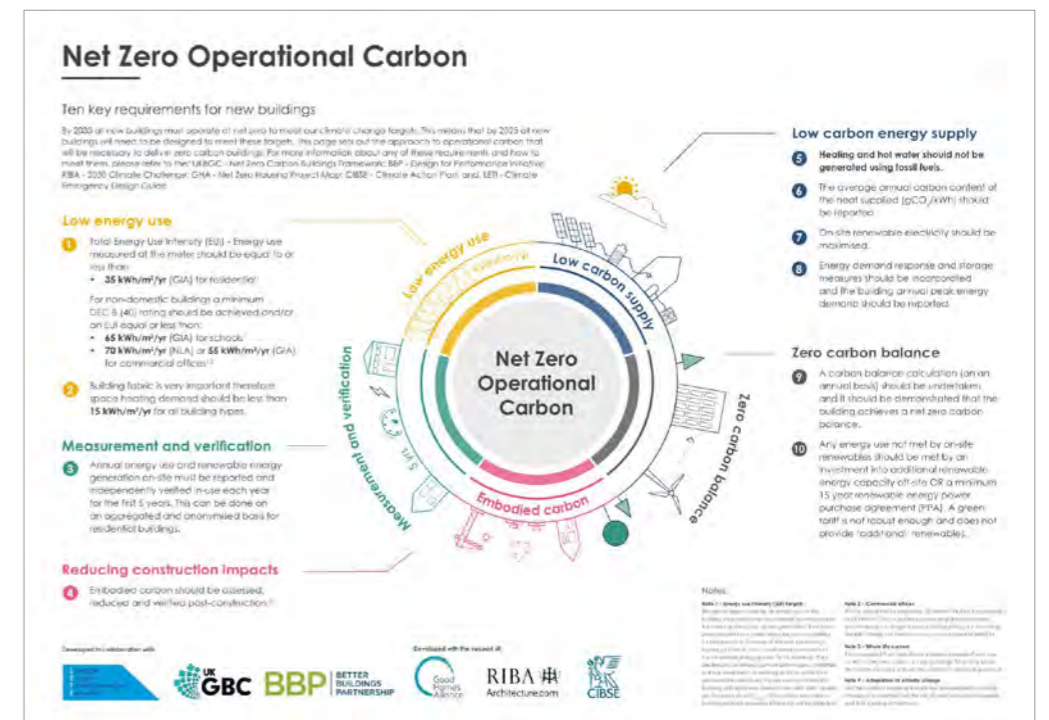

Figure 31 - Ten key requirements for a Net Zero Operation Carbon - A summary Developed by LETI in collaboration with UKGBC and BBP, and supported by the Good Homes Alliance, RIBA and CIBSE (source: www.leti.london)

## Section 2

# What are the issues with the current approach to offsetting?



- The 35% on-site carbon reduction requirement
- Carbon offsetting
- Metric and methodology
- The role of the planning system

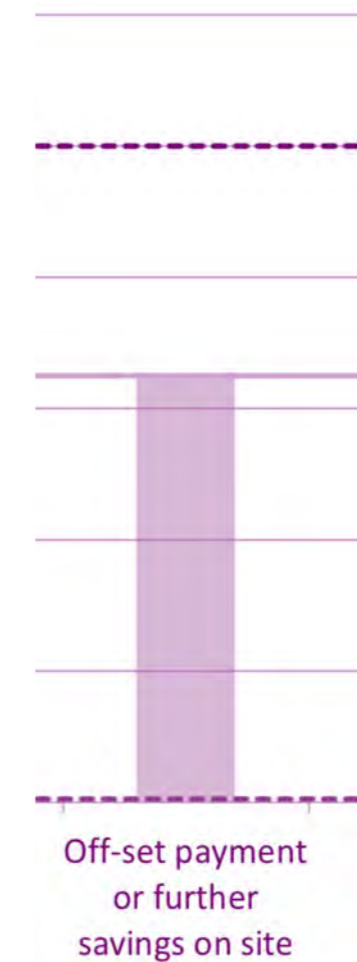

*Extract from the GLA Energy guidance*



# Issues with the 35% on-site carbon reduction requirement

## A requirement first mandated 7 years ago

The London Plan 2011 introduced a requirement for all new developments to achieve, from 2013, a 40% on-site improvement over Part L 2010. When Part L 2013 was introduced, this was translated into a **35% on-site improvement on-site over Part L 2013**. Since then, however, a number of changes have been made to planning policy and guidance:

- Applicants are now required to offset the residual regulated emissions or achieve further savings on-site. In practice, carbon offsetting is often favoured.
- Since January 2019, applicants have to use the SAP 10.0 carbon factor for electricity (233 gCO<sub>2</sub>/kWh) instead of the out-dated Buildings Regulations factor (519 gCO<sub>2</sub>/kWh).
- The impact of the heating system on local air quality is given much more importance.

## It sets the standard... at 35%

Unfortunately, setting the minimum requirement at 35% with a relatively cheap carbon offset price has created a culture where 35% has become the average level of performance on-site, rather than the minimum. This is illustrated by the graph in the top right corner which summarises the review of energy statements submitted to the five London boroughs. The change in carbon factor should have led to further reduction on-site but does not appear to have had a major impact.

## Regulated energy only

The policy focuses only on regulated energy\*. This means that unregulated energy use is not addressed at all by the planning system.

## The performance gap

There are a number of reasons why the actual performance of new buildings is, on average, significantly worse than anticipated. The current Part L calculation system does not address this issue in a satisfactory way as it cannot be monitored post construction.

## Conclusion

The current approach, and in particular the 35% Part L improvement requirement, is not fit-for-purpose to address the issues summarised above and acknowledged widely in the building industry for a number of years now.

\* Generally, 'regulated' energy consumption results from controlled, fixed building services including heating and cooling, hot water, ventilation and lighting. 'Unregulated' energy consumption results from processes that are not covered by building regulations, i.e. ICT equipment, lifts, refrigeration systems, cooking equipment and other 'small power'. There are however complexities (e.g. heating used outside of NCM profiles is not technically 'regulated').



Figures 32 and 33 - The London Plan 2011 and the draft London Plan both refer to the same level of on-site carbon reduction. It was mandated from 2013.

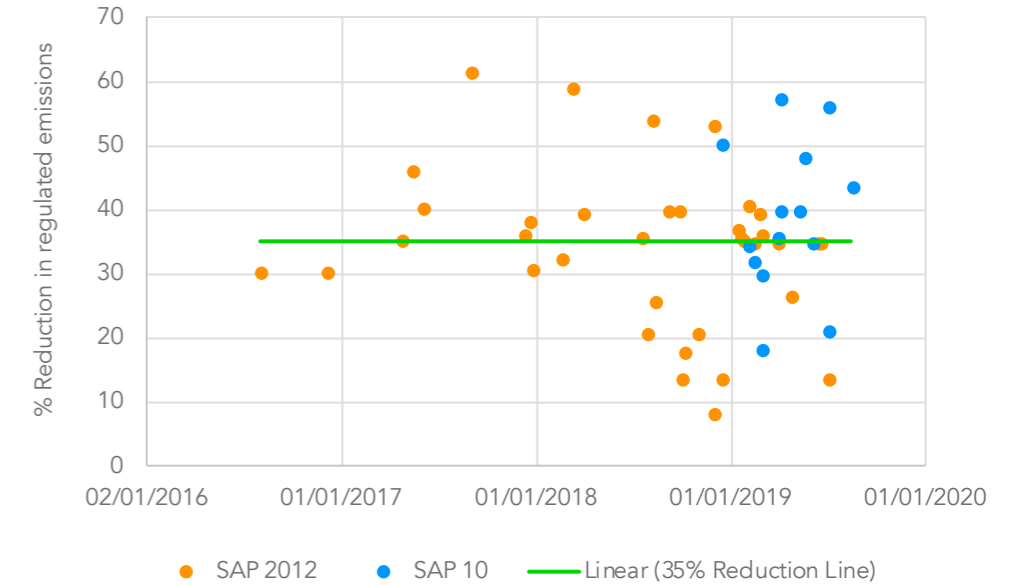

Figure 34 - Review of on-site carbon reduction commitments in planning applications. The planning applications submitted using the SAP 10.0 carbon factor do not appear to achieve a greater level of Part L performance on-site. They should.



Figure 35 - Building Performance Evaluation Programme: Early Findings from Non-Domestic Projects © Innovate UK



Figure 36 - Closing the Gap between Design & As-Built Performance: Evidence Review Report © Zero Carbon Hub

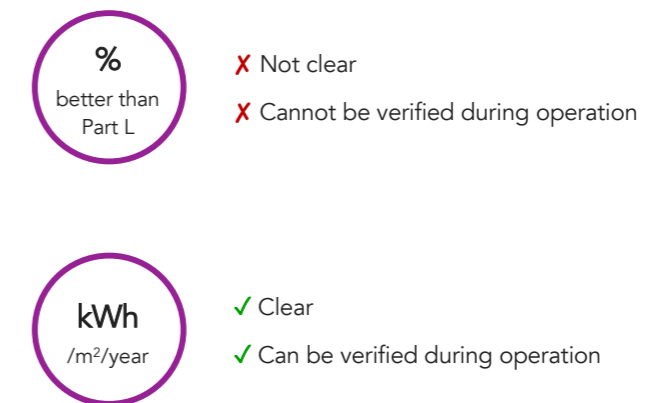

Figure 37 - Moving towards a kWh/m<sup>2</sup>/yr metric would enable to create a virtuous feedback loop between design, construction and operation

# Issues with carbon offsetting

## Carbon offsetting is the default solution, and it displaces the problem

A large carbon offsetting contribution from a new development can be seen as a sign of policy failure: the building's regulated carbon emissions are significantly higher than the policy objective (zero regulated carbon emissions on-site) and carbon offsetting is shifting responsibility to the local authority to make the scheme compliant by saving carbon elsewhere in the borough, which has its own challenges. It would be better for the planning application not to rely heavily on this.

There are also concerns about the s106 contribution being negotiated down and, in some cases, not used and returned to the applicant if it has not been used in 5 years, meaning that carbon emissions would actually not be saved.

## Carbon offsetting is not a long term solution

Forecasts, including from the Committee on Climate Change suggest that in a net zero scenario, **residual emissions in 2050 should be no more than 3-10% of current emissions across the UK.** Over 80% of residual emissions in 2050 are forecast to occur in the aviation, agriculture, industry and waste sectors. This means that acceptable residual emissions in other sectors such as buildings are almost zero. Modest levels of residual emissions are acceptable over the next decade, on the basis they reduce close to zero by 2050. This means that emissions from both new buildings and existing buildings will have to be near zero and that transferring the emission reductions from one to the other is not sustainable in the long term.

## Strategies to address residual emissions

**Housing retrofit** to fit heat pumps and improve building fabric efficiency can reduce emissions and fuel poverty, while improving air quality. It cannot remove atmospheric carbon.

**Solar panels** fitted to buildings use sites that have already been developed to provide cheap clean electricity. They can be installed in conjunction with demand management systems. They also cannot remove atmospheric carbon.

**Renewable energy** funded but installed outside of the borough contributes toward decarbonisation of the electricity grid. It also cannot remove atmospheric carbon.

**Forestation** offers the only practical strategy to remove atmospheric carbon. Total potential is very limited though, therefore emissions must be reduced as much as possible first.

**Carbon Capture and Storage (CCS).** Drax power station is amongst a handful of Bioenergy with Carbon Capture and Storage pilot projects worldwide, which the Committee on Climate Change view as an essential technology. It is currently capturing just 1 tonne of CO<sub>2</sub> per day however, so is not a viable option at present.

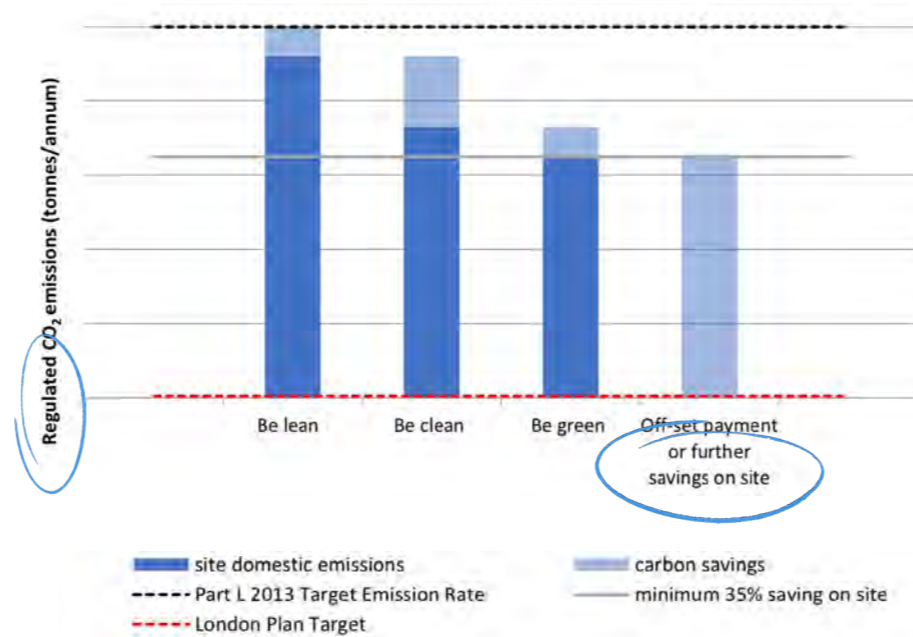

Figure 38 - Extract from the GLA Energy guidance. Although further savings on site are encouraged, off-set payments are often favoured.

Recommended Strategy	2020 - 2030	2030 - 2040	2040 - 2050
Housing retrofit in the borough	✓	✓	✗
Solar photovoltaic panels in the borough	✓	✓	✗
Renewable energy outside of the borough	✓	✗	✗
Carbon removal (e.g. reforestation outside of the borough)	✓	✓	✓

Figure 39 - Recommended strategies to offset residual emissions and whether they will remain applicable in the short term, medium term and long term

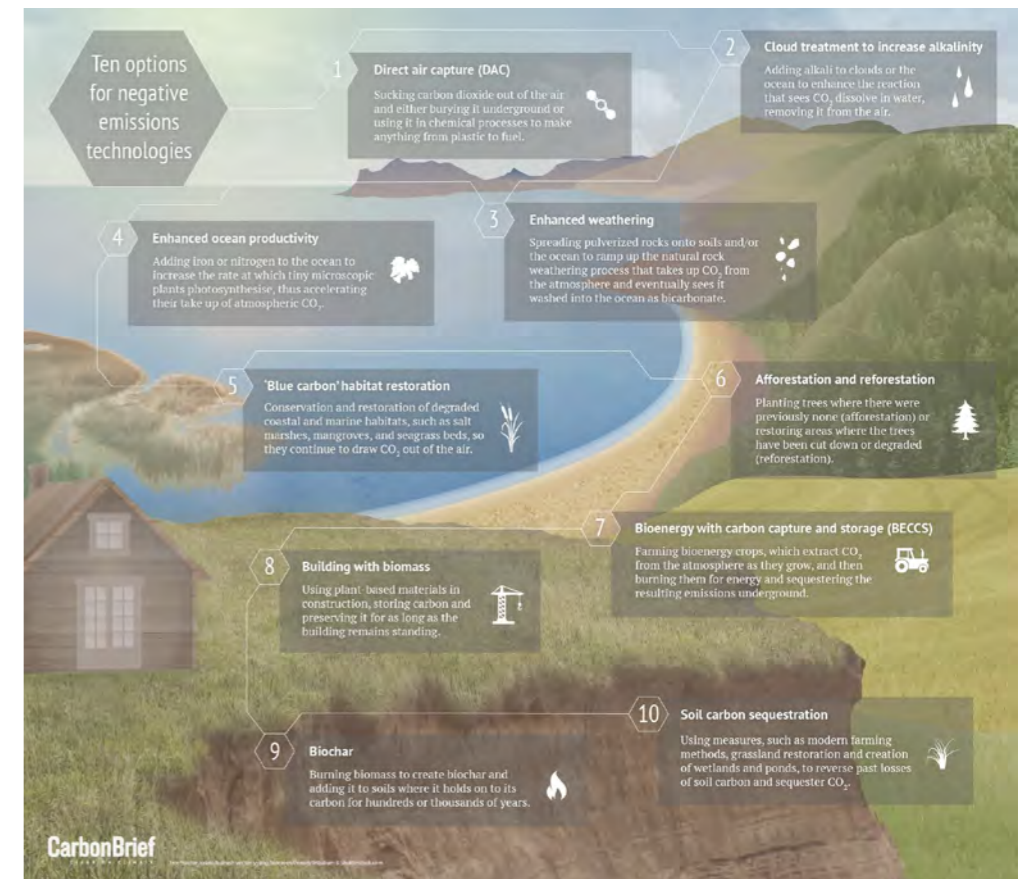

Figure 40 - Ten options for the removal of carbon from the atmosphere (also referred to as 'negative emissions') Source: © Carbon Brief



## Part L modelling should not be used to predict future energy use or carbon emissions... but it is

The text below is an extract from CIBSE TM54: *Evaluating operational energy performance of buildings at the design stage*:

In the UK, energy models are used at the design stage to compare design options and to check compliance with Building Regulations. These energy models are not intended as predictions of energy use, but are sometimes mistakenly used as such. In some other countries, total energy use at the design stage is estimated through voluntary standards [...] [which] encourage the estimation of energy use at the design stage and provides guidance for designers/modellers.

There are several reasons why the current approach based on Part L models is not delivering the outcomes required:

- The relative improvement approach (e.g. 10% better than a comparable 'notional' building) does not do not reward more efficient building forms.
- Critical energy efficiency parameters (e.g. distance of intake and exhaust MVHR ducts to the elevation) are not considered in Part L calculations.
- Standard assumptions are being made which do not reflect the intended use (e.g. occupancy)
- Part L does not cover unregulated energy (e.g. white goods, equipment).

### Predicted Energy Use Intensity (EUI): a better metric

The most successful and efficient energy standards are all based on clear, transparent and absolute performance metrics : Passivhaus, AECB Silver, Better Buildings Partnership Design for Performance, NABERS , DEC A rating performance contracts. These standards lead to energy use which can be up to 3 times lower.

An Energy Use Intensity (EUI) metric in 'kWh/m<sup>2</sup>' has the advantage of being a very basic metric which can easily be compared against post occupancy surveys of comparable buildings during the briefing stage, be evaluated during the design, be checked during operation and be translated into both carbon and financial costs and savings throughout the process.

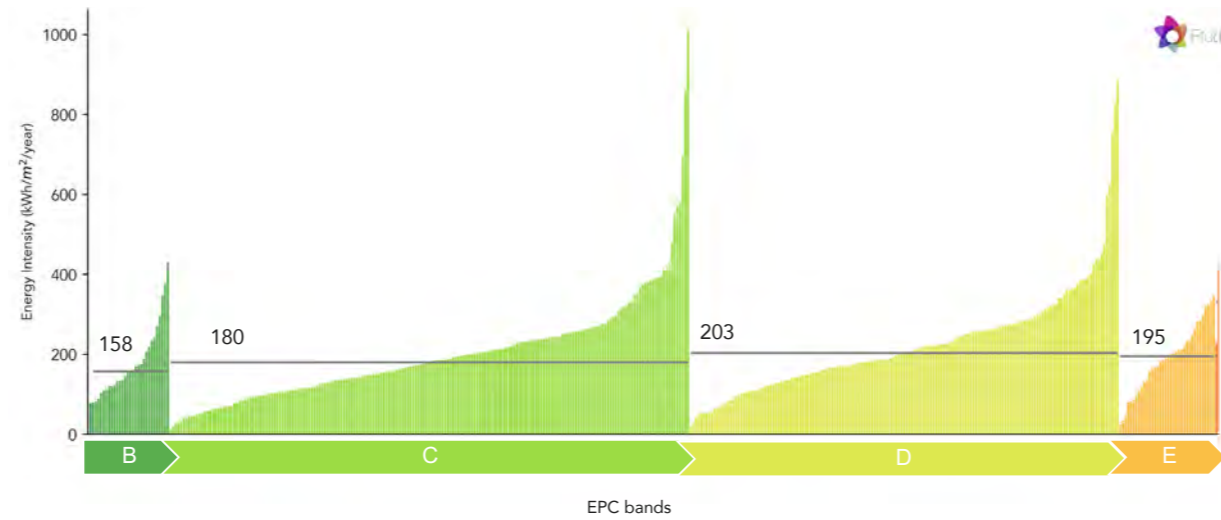

Figure 41 - A comparison of the EPC's energy efficiency rating with metered energy consumption of 420 homes shows huge variance in the energy consumed within each rating band

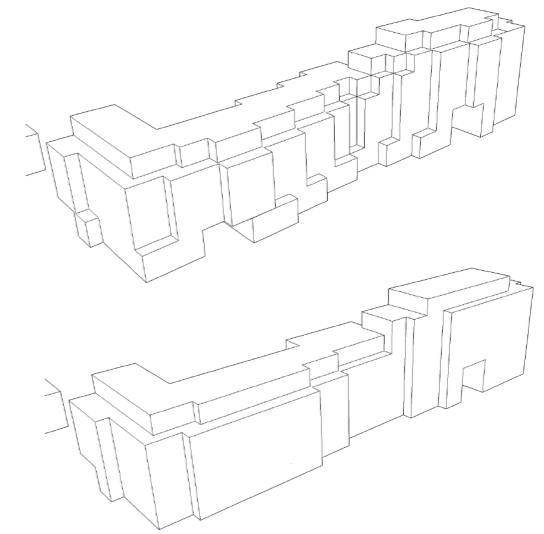

Figure 42 - A more efficient form is important for ultra-low energy buildings. Unfortunately Part L does not reward more efficient designs. The % over Part L 2013 of the two buildings above would be broadly similar.

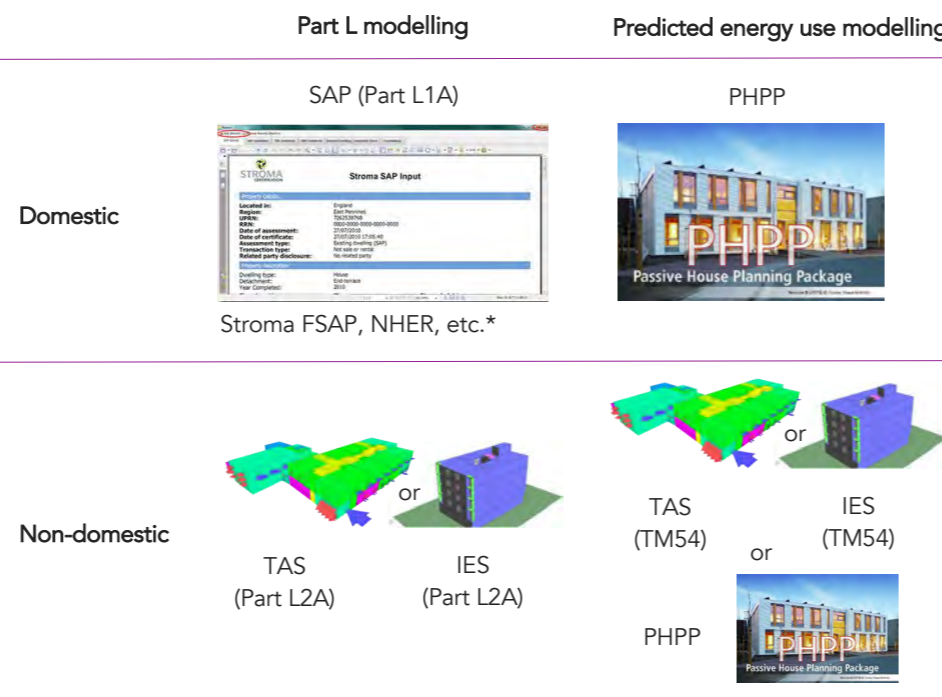

Figure 43 - Part L modelling and predicted energy use modelling are different. As an industry we need to move towards predicted energy use modelling.

Option 1  
Individual MVHR



Duct Lengths <2m

Heat Recovery  
86%

Option 2  
Individual MVHR



Duct Lengths 11m

Heat Recovery  
56%

Figure 44 - Indicating the location of the MVHR unit within the dwelling (and the duct length to the elevation) is not required in SAP but has a very significant impact on the system's actual energy efficiency

# The role of the planning system and the road to Net Zero Carbon

## The power of policy

The potential for policy to lead to significant positive changes in building design and construction within each borough cannot be understated. New policies should be bold and reflect the urgency of the changes that we need to see to avert catastrophic climate change.

The current system is fit for purpose to deliver the current policy but looking ahead, it is not appropriate to deliver Net Zero Carbon buildings.

In the medium term, we would recommend a change of system and an alignment between the planning metrics/methodology and the Net Zero Carbon metrics/methodology and ambition.

In the short term, we would recommend using carbon pricing to create the right incentives and drive building design and delivery in the right direction.

## Key roles for the planning system

The road to Net Zero Carbon involves stepping up the requirements towards the following objectives:

- Objective 1: **reduce energy use**
- Objective 2: **low carbon heat**
- Objective 3: **low carbon electricity**
- Objective 4: **affordable energy**
- Objective 5: **deliver co-benefits**

The adjacent table summarises our recommendations for each of these objectives and the role that carbon pricing can play. Although it can help, some more significant changes would be required to achieve these objectives.



The carbon offsetting price can play an important role to help deliver carbon and energy policy or guidance, but it can only help. Changes to policy and guidance will be required if we are to deliver Net Zero Carbon buildings soon.

	Objective 1 Reduce energy use	Objective 2 Low carbon heat	Objective 3 Low carbon electricity	Objective 4 Quality homes and affordable energy	Objective 5 Deliver co-benefits
<b>Proposal</b>	<b>1.1 Require buildings which use less than energy</b> (e.g. 50% less than standard new buildings in line with BEIS' Energy Mission).	<b>2.1 Phase out gas heating.</b> Gas boilers and gas CHP should not be used*	<b>3.1 Incorporate as much renewable energy as possible</b> (solar PVs being the most suitable technology in London)	<b>4.1 Ensure that all low carbon homes are also affordable to run,</b> particularly affordable and social rent units	<b>5.1 Favour systems which have no adverse impact on air quality.</b> There are significant co-benefits of low carbon buildings.
<b>Can the carbon offset price contribute to this objective?</b>	~	~	✓	✗	✓
<b>Comment</b>	A change in metric (i.e. kWh/m <sup>2</sup> ) and the requirement to predict energy use would be more effective (e.g. Toronto's approach).	A no gas policy would be more effective. If applicants were required to quantify their residual emissions over 30 years, carbon pricing could play this role.	Carbon pricing can incentivise more PVs on site if the carbon price is higher than the cost of adding more PVs.	Carbon is not a proxy for energy costs/bills.	Carbon emissions from buildings are generally a proxy for their impact on local air quality.
<b>Proposal</b>	<b>1.2 Reward/incentivise best practice</b> (e.g. Passivhaus certified building)	<b>2.2 Reward systems with low carbon content of heat</b>	<b>3.2 Enable a smart grid</b> through incorporation of demand response	<b>4.2 Deliver construction quality</b> to reduce the performance gap	<b>5.2 Reduce refrigerants' impact on climate change</b>
<b>Can the carbon offset price contribute to this objective?</b>	✓	✓	✗	✗	✗
<b>Comment</b>	The carbon offsetting payment from a Passivhaus scheme should be significantly smaller than an equivalent 'minimum' planning compliant scheme.	Carbon pricing can incentivise low carbon heat.	Part L does not quantify the carbon benefits of demand response.	The performance gap is not adequately addressed by Part L and so carbon pricing cannot play a significant role.	Some refrigerants have a very high global warming potential and some systems a high leakage rate, but carbon emissions are not a proxy for this impact.

Table 8 - Potential contribution from carbon pricing mechanisms.

\* unless there is a clear plan for decarbonisation of the heat network



# Section 3

## How can carbon pricing incentivise greater regulated carbon reductions on-site?



- Current approach to carbon offsetting
- Part L performance of different specifications for seven building typologies
- Associated construction costs
- How can carbon pricing incentivise greater savings on site?
- Will the carbon price be sufficient to save carbon off-site?

Reduction in CO <sub>2</sub> - SAP 10.0 (reg)		With PV			
		Gas boiler	Direct electric	Heat pump	Better heat pump
Fabric & Ventilation	Business as usual	26%	40%	71%	87%
	Good practice	36%	51%	77%	91%
	Ultra-low energy	51%	66%	86%	96%

## Current carbon offsetting prices

The adjacent table summarises the current offsetting prices for residual regulated carbon used by the five London Boroughs. The range is between £60 and £95 per tonne CO<sub>2</sub> and the offsetting period used is 30 years.

### Which carbon factor?

Over the next 30 years, the carbon content of electricity is forecasted to reduce. This means that instead of being required to offset 30 times the residual carbon emissions using a 'static' set of carbon factors, applicants could forecast the development's residual emissions over the next 30 years. We have not assumed this approach at this stage although it could be considered.

### The non-traded cost of carbon

This approach has been the most widely used to inform the carbon offset price in the UK so far. The Zero Carbon Hub used this approach and assumed a 'central scenario' in 2012 and it was also used by the GLA/AECOM when they considered carbon offsetting and allowable solutions. The GLA have and opted for the 'high scenario' in 2017.

We have updated this analysis to identify the non-traded carbon price appraisal values (2019 prices) for a home built in 2021 which is required to abate 30 years of carbon. Using a simple average for the carbon price in the period 2021-50 and a constant 3.5% discount rate would give approximately **£103/tCO<sub>2</sub>** over 30 years, i.e. £3,090/tCO<sub>2</sub> over the 30-year period for the 'high scenario'. This could constitute the new carbon 'floor price'.

### The cost of additional PVs as a proxy

Using a reasonable cost rate for a high output PV system with micro-inverters and the SAP 10.0 factor (i.e. 233 gCO<sub>2</sub>/kWh) for electricity to be consistent with the planning energy strategy calculations, installing additional PVs to achieve further improvement over Part L on-site would cost approximately **£190/tCO<sub>2</sub>**.

This number is expected to increase to £325/t CO<sub>2</sub> with an electricity carbon factor of 136 gCO<sub>2</sub>/kWh (SAP 10.1).

	Barking & Dagenham	Ealing	Haringey	Greenwich	WCC
Annual carbon offset price	£60 /tCO <sub>2</sub> /yr	£60 /tCO <sub>2</sub> /yr	£95 /tCO <sub>2</sub> /yr	£60 /tCO <sub>2</sub> /yr	£60 /tCO <sub>2</sub> /yr
Number of years	30	30	30	30	30
Total carbon offset price	£1,800 /tCO <sub>2</sub>	£1,800 /tCO <sub>2</sub>	£2,850 /tCO <sub>2</sub>	£1,800 /tCO <sub>2</sub>	£1,800 /tCO <sub>2</sub>
Same price for all developments?	yes	yes	yes	yes	yes

Table 9 - Current carbon offset price used by the five London Boroughs

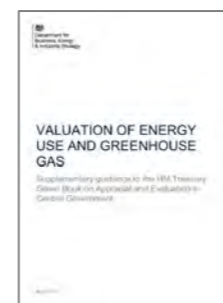

This document is a supplement to HM Treasury's Green Book, providing specific guidance on how analysts should quantify and value energy use and emissions of greenhouse gases. It is intended to aid the assessment of proposals that have a direct impact on energy use and supply and those with an indirect impact (e.g. planning, construction).

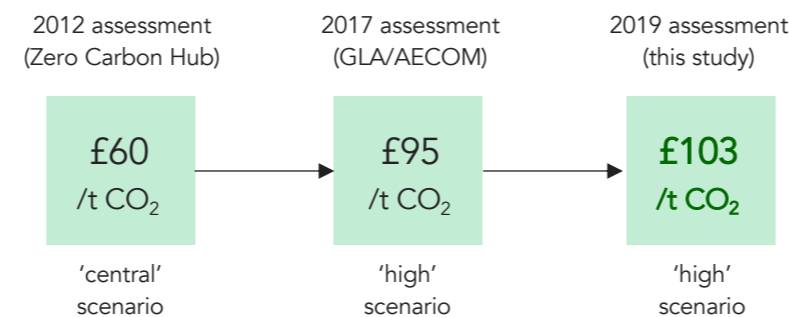
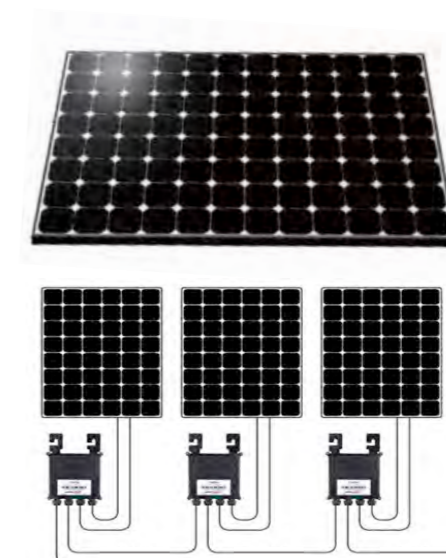

Figure 45 - Carbon offset price using the the non-traded cost of carbon approach

Does it incentivise?	Current approach
Greater carbon savings on-site?	✗
Greater energy use reduction?	✗
Best practice (e.g. Passivhaus)?	✗
Low carbon heat?	~
Low impact on air quality	~
More PVs on site?	✗

Table 10 - Test of current approach to carbon offsetting against key objectives



**£190**  
/t CO<sub>2</sub>

Figure 46 - If the carbon offset price is to incentive more PVs on-site, it should be set at **more than £190/t CO<sub>2</sub>** assuming an electricity carbon factor of 233 gCO<sub>2</sub>/kWh (SAP 10.0). This number is expected to increase to £325/t CO<sub>2</sub> with an electricity carbon factor of 136 gCO<sub>2</sub>/kWh (SAP 10.1)



# A flat carbon offset price? A tiered or a stepped approach? Our methodology

## Testing the impact of different carbon offset prices

The adjacent table summarises the tests we have undertaken with different approaches to carbon pricing. Using carbon pricing to achieve better outcomes is the main objective of this study.

### What is technically achievable on-site?

One of the most important outcomes which should be achieved is greater carbon savings on site. Therefore different specifications were modelled for different building typologies to establish which levels of improvement over Part L were technically achievable, particularly by the combinations of specifications which should be incentivised.

### Flat rate, tiered rate or stepped rate?

We have considered three different approaches to the carbon offset price. They are explained on the three diagrams below. We have also investigated three carbon prices:

- £1,000/tCO<sub>2</sub> as a strong signal that greater carbon savings on site should be achieved.
- £300/tCO<sub>2</sub> as it incentivises PVs on site.
- £100/tCO<sub>2</sub> as it represents the updated carbon offset 'floor price' recommended by the GLA (£95/tCO<sub>2</sub>).

Does it incentivise?	Test
Greater carbon savings on-site?	?
Greater energy use reduction?	?
Best practice (e.g. Passivhaus)?	?
Low carbon heat?	?
Low impact on air quality?	?
More PVs on site?	?

Table 11 - Tests undertaken as part of this study

Reduction in CO <sub>2</sub> - SAP 10 (reg)	With PV			
	Gas boiler	Direct electric	Heat pump	Better heat pump
Business as usual	26%	40%	71%	87%
Good practice	36%	51%	77%	91%
Ultra-low energy	51%	66%	86%	96%

Table 12 - How can carbon offsetting incentivise lower energy and carbon buildings?



Figure 47 - Carbon offsetting price: the flat rate approach

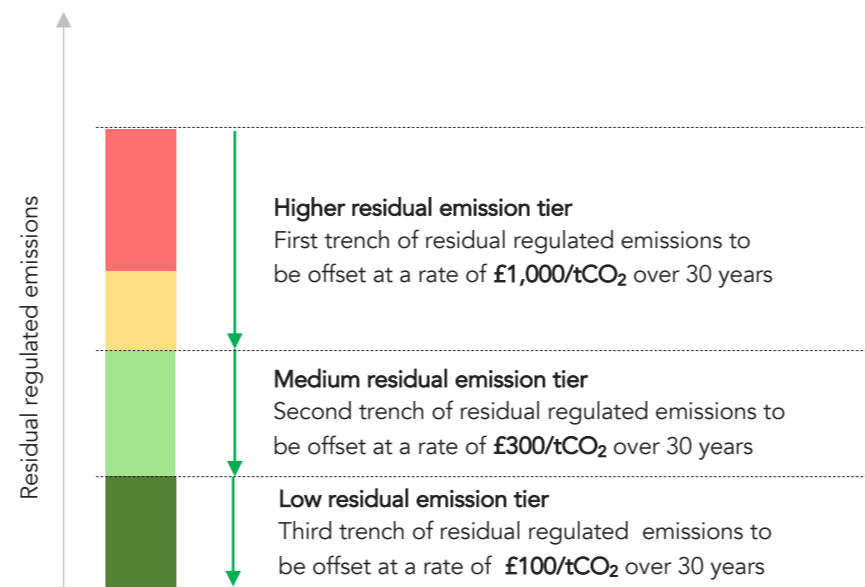

Figure 48 - Carbon offsetting price: the tiered rate approach  
The total carbon offset contribution will then be the sum of the above calculations

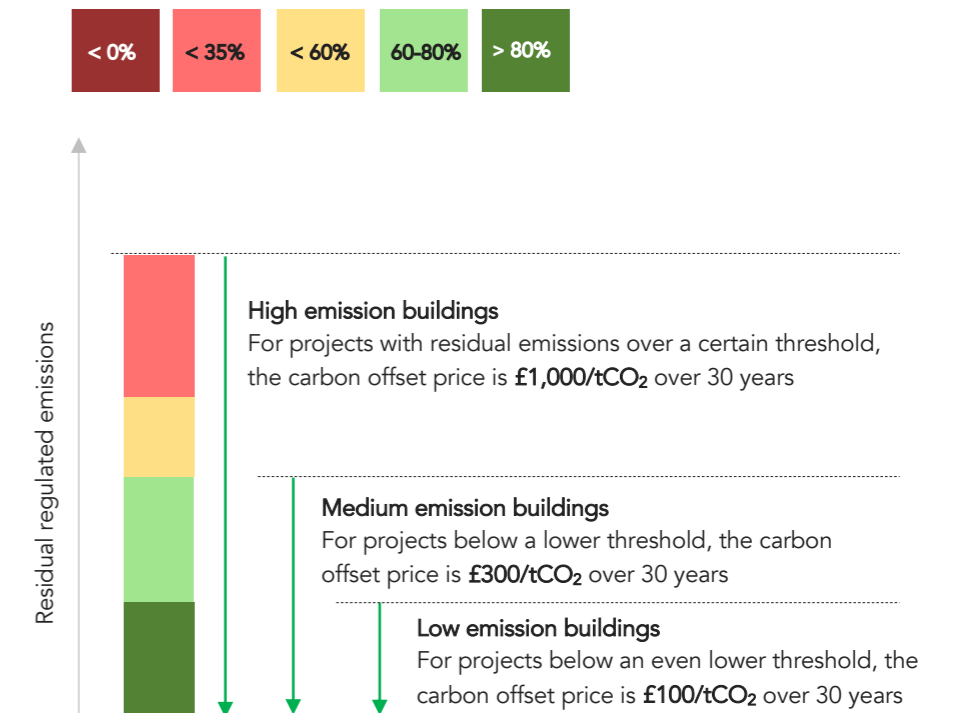

Figure 49 - Carbon offsetting price: the stepped rate approach

## Methodology

We carried out Part L modelling using accredited softwares and we post-processed the results using different carbon factors:

- **CO<sub>2</sub>-Building regs:** 519 gCO<sub>2</sub>/kWh for electricity. The outdated carbon factor used for Buildings Regulations.
- **CO<sub>2</sub>-SAP 10.0:** 233 gCO<sub>2</sub>/kWh for electricity. The carbon factor recommended by the current GLA guidance.
- **CO<sub>2</sub>-Future:** 71 gCO<sub>2</sub>/kWh for electricity. The estimated average carbon factor over the period 2020-2050.

## Typologies modelled

After discussions with the five boroughs, the typologies summarised in Table 13 were selected and modelled.

## Different fabric and ventilation specifications

1. **Business as usual** aims at representing the average specifications currently being proposed in current planning applications in London.
2. **Improved** specifications represent an improvement on 'Business as usual'.
3. **Ultra-low energy** specifications represent best practice and can be considered consistent with Passivhaus levels of specifications.

## Different heating systems

As indicated previously, different we modelled four different levels of carbon content of heat for each typology:

- Gas boilers** should not be incentivised (as gas needs to be phased out) but still represent the 'baseline'\*.
- Direct electric/VRF systems** represent the most commercially attractive electric heating systems for domestic and non-domestic buildings respectively.
- Heat pump** represents a heating system based on the heat pump technology (individual, communal or district scale).
- Better heat pump** represents a similar system but with better efficiencies (individual, communal or district scale).

## Solar Photovoltaic panels (PVs):

- **No PVs**
- **With PVs:** a pragmatic but ambitious level of roof PV coverage

\* Gas boilers should only be considered where there is a robust plan for low carbon heat and when they are credibly being used as a stepping stone towards this objective.

		No of storeys	GIA (sqm)
Terrace house	New build	2/3	95
Medium-rise apartment building	New build	5	3,200
High-rise apartment building	New build	25	14,600
Education building (e.g. school)	New build	3/4	6,000
Hotel	New build	9	3,600
Office building	New build	7	4,000
Office building	Refurbishment	7	4,000

Table 13 - Typologies modelled. These are considered to be appropriate representative examples of the predominant development types occurring in the boroughs. Please note that the results presented in this document reflect the above and should only be considered as indicative of the results to be achieved for the typology

	Fabric and Ventilation level		
	1. Business as usual ★	2. Good practice ★★	3. Ultra-low energy ★★★
Average wall U-value	0.18 W/m <sup>2</sup> K	0.15 W/m <sup>2</sup> K	0.13 W/m <sup>2</sup> K
Average roof U-value	0.15 W/m <sup>2</sup> K	0.13 W/m <sup>2</sup> K	0.10 W/m <sup>2</sup> K
Ventilation	Good quality MVHR long ducts to outside	High quality MVHR long ducts to outside	High quality MVHR short ducts to outside
Effective system heat Recovery efficiency	85%	90%	90%
Ventilation system SFP	0.7 W/l/s	0.5 W/l/s	0.5 W/l/s
Airtightness	<3m <sup>3</sup> /m <sup>2</sup> h	<3m <sup>3</sup> /m <sup>2</sup> h	<1m <sup>3</sup> /m <sup>2</sup> h

Table 15 - Example of fabric and ventilation specifications for the **medium-rise apartment building**

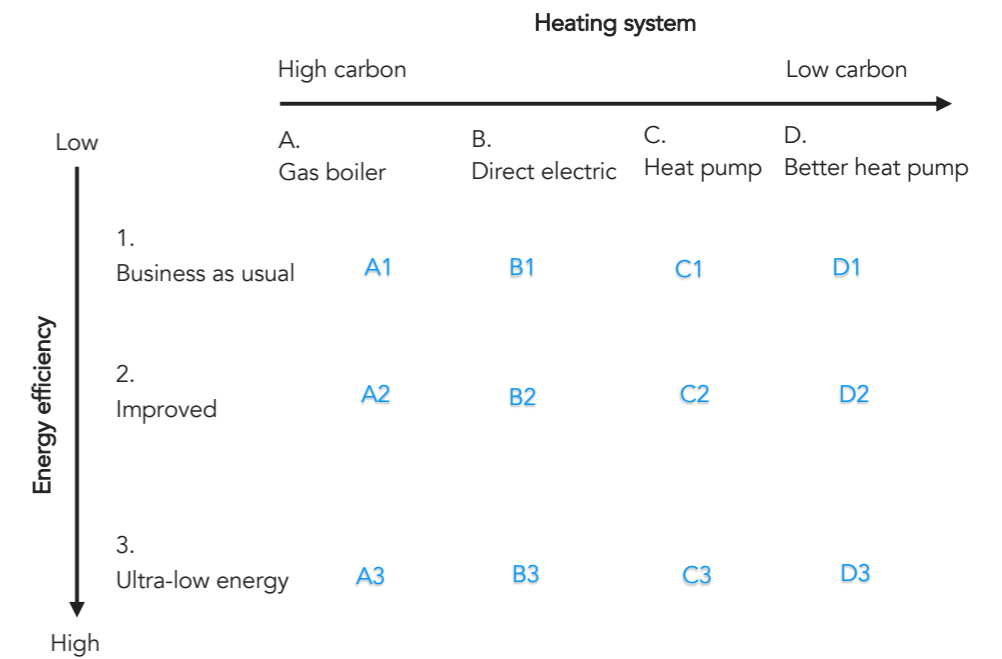

Table 14 - Combination of options investigated

	> 250 gCO <sub>2</sub> /kWh	200-250 gCO <sub>2</sub> /kWh	100-200 gCO <sub>2</sub> /kWh	< 100 gCO <sub>2</sub> /kWh
	A. Gas boiler	B. Direct electric	C. Heat pump	D. Better heat pump
Heating Source	Communal gas boiler serving a communal heating system	Direct electric panel radiators	Heat pumps serving a communal heating system	An ambient loop fed with Individual heat pumps (WSHP) in each residential unit
Heating system	LTHW radiators fed by HIU 70°C /50°C	Direct electric panel radiators	LTHW radiators fed by HIU 65°C /50°C	LTHW radiators
Hot water system	HIU provides instantaneous hot water	80L hot water store with immersion heater	HIU provides instantaneous hot water	80L hot water store with immersion heater WWHR for the showers
Seasonal efficiency	93%	100%	190% space heating 210% water heating	330% space heating 280% water heating

Table 16 - Example of heating systems considered for the **medium-rise apartment building**



# Terrace house | Performance against Part L

## Performance against 'be lean' requirement\*

Be Lean Reduction in CO <sub>2</sub> - SAP 10.0 (reg)		≥10% (draft London Plan requirement)
Terraced house		
Fabric & Ventilation	Business as usual	10%
	Good practice	19%
	Ultra-low energy	37%

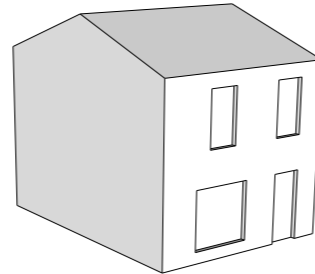

A row of 8 terrace houses has been considered as a case study. The mid-terrace floor area is 95 sqm GIA.

The three Fabric & Ventilation specifications comply with the minimum 'be lean' requirement for domestic buildings assuming the SAP 10.0 carbon factors. It is therefore not sufficient to encourage better levels of energy efficiency. The carbon offset price could be used to incentivise this.

## What can technically be achieved with energy efficient fabric and services, and low carbon heat?

Focusing on the combinations that the planning system should incentivise, very significant improvements over Part L can be achieved **on-site** with the SAP 10.0 carbon factors (>80%). This demonstrates that **the 35% Part L improvement on-site is not adequate for terrace houses**. Unless policy can be changed, the carbon offset price should correct this.

## Impact of PVs

PVs are not necessary to achieve the minimum 35% improvement on-site. **Unless the carbon offset price is higher than the cost of installing PVs, their inclusion in the design will not be incentivised.** This should be considered.

## Impact of carbon factor

If the analysis is done using an estimate for the future carbon factor for electricity (i.e. 71 gCO<sub>2</sub>/kWh) instead of SAP 10.0 (i.e. 233 gCO<sub>2</sub>/kWh), the conclusions above remain the same.

\* Under the 'be lean' requirement of the new London Plan, residential buildings should achieve a minimum 10% improvement over Part L from energy efficiency alone (i.e. building fabric and ventilation).

Fabric & Ventilation	Reduction in CO <sub>2</sub> - SAP 10.0 (reg)	With PV			
		Gas boiler	Direct electric	Heat pump	Better heat pump
Business as usual		47%	53%	96%	103%
Good practice		58%	62%	100%	106%
Ultra-low energy		75%	81%	107%	112%

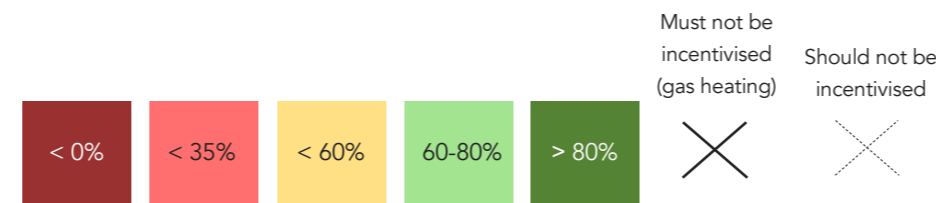

Table 17 - Terrace house - Improvement over Part L assuming 233 gCO<sub>2</sub>/kWh (SAP 10) for grid-supplied electricity

Fabric & Ventilation	Reduction in CO <sub>2</sub> - SAP 10.0 (reg)	With PV			
		Gas boiler	Direct electric	Heat pump	Better heat pump
Business as usual		47%	53%	96%	103%
Good practice		58%	62%	100%	106%
Ultra-low energy		75%	81%	107%	112%

PVs covering 50% of the roof

Fabric & Ventilation	Reduction in CO <sub>2</sub> - SAP 10.0 (reg)	No PV			
		Gas boiler	Direct electric	Heat pump	Better heat pump
Business as usual		18%	16%	59%	65%
Good practice		18%	24%	62%	68%
Ultra-low energy		38%	43%	69%	74%

Table 18 - Terrace house - Impact of PVs

Fabric & Ventilation	Reduction in CO <sub>2</sub> - SAP 10.0 (reg)	With PV			
		Gas boiler	Direct electric	Heat pump	Better heat pump
Business as usual		47%	53%	96%	103%
Good practice		58%	62%	100%	106%
Ultra-low energy		75%	81%	107%	112%

Electricity carbon factor set at 233 gCO<sub>2</sub>/kWh (SAP 10)

Fabric & Ventilation	Reduction in CO <sub>2</sub> - Future (reg)	With PV			
		Gas boiler	Direct electric	Heat pump	Better heat pump
Business as usual		28%	84%	99%	101%
Good practice		38%	87%	100%	102%
Ultra-low energy		58%	94%	102%	104%

Electricity carbon factor set at 71 gCO<sub>2</sub>/kWh (Estimate 2020-2050)

Table 19 - Terrace house - Impact of changing the electricity carbon factor

## Construction costs

The baseline in terms of construction costs is the 'Business as usual + Gas boiler + PVs' scenario. This scenario is compliant with the London Plan requirement of a minimum 35% carbon reduction over Part L.

The additional construction costs of the four lowest carbon options compared to this baseline are comprised between 2.1% and 5.2%.

This excludes any carbon offsetting cost.

It is important to note that this comparison is based on exactly the same design and does not include the cost reductions and efficiencies which can be achieved on a low energy design process (e.g. form factor).

## Development costs

The impact would be only between 0.8% and 2.1% if the whole development costs were considered.

## Additional construction cost vs Part L CO<sub>2</sub> reduction

The graph on the right hand side highlights the relationship between uplift in cost and reduction in carbon emissions.

### Notes on costs:

The uplift costs associated with each specification option were estimated based on Currie & Brown's cost datasets for energy efficiency and low carbon technologies which incorporate information from market prices obtained, specific market testing and first principles cost planning by their specialist quantity surveyors. The costs are based on Q3 2019 prices and reflect a London / South East cost base. Costs were developed for each affected element to identify the variance in price between the baseline and the enhanced specifications.

Those elements that are not materially affected by the energy efficiency / low carbon technology options, eg substructure, roof coverings, kitchen and bathrooms, etc, were not costed in detail. Instead these costs were incorporated within the 'balance of construction' cost was estimated by reference to a typical whole building construction cost per m<sup>2</sup> for the building type in question. This whole building cost was then adjusted for each option based on the variance in the elements costed in detail to determine the overall percentage impact on construction costs.

The potential impact on total development cost was estimated on the basis of the construction cost representing c.40% of the total development costs with the balance being comprised of land cost, finance and project fees and other planning requirements.

Reduction in CO <sub>2</sub> - SAP 10.0 (reg)		With PV			
		Gas boiler	Direct electric	Heat pump	Better heat pump
Fabric & Ventilation	Business as usual	47%	53%	96%	103%
	Good practice	58%	62%	100%	106%
	Ultra-low energy	75%	81%	107%	112%

Table 20 - Terrace house - Improvement over Part L assuming 233 gCO<sub>2</sub>/kWh (SAP 10) for grid-supplied electricity (Same table as previous page)

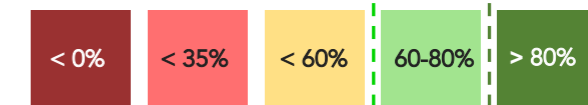

## Terrace house (~ £1,800/m<sup>2</sup> baseline construction cost)

% uplift in cost per m <sup>2</sup> of construction		With PV			
		Gas boiler	Direct electric	Heat pump	Better heat pump
Fabric & Ventilation	Business as usual	0.0%	-2.9%	0.8%	1.5%
	Good practice	1.2%	-1.6%	2.1%	2.8%
	Ultra-low energy	3.6%	0.8%	4.4%	5.2%

Table 21 - Terrace house - Additional construction costs (£/m<sup>2</sup>) compared with the 'Business as usual + Gas boiler scenario + PVs' baseline scenario - Analysis by Currie & Brown

The four lowest carbon options are outlined

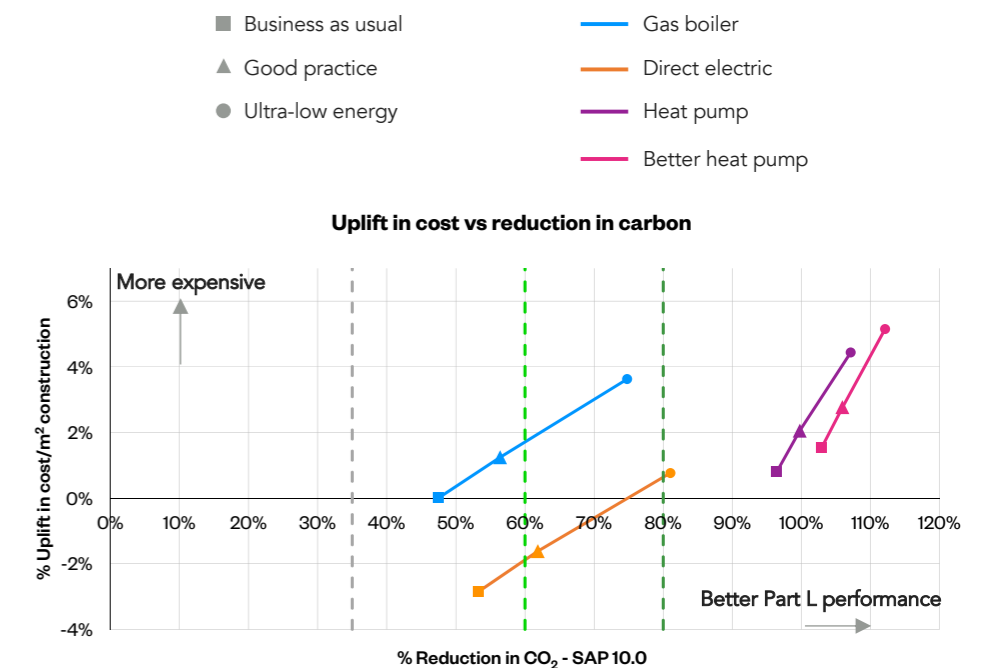

Figure 48 - Terrace house - Additional construction costs vs Part L reduction



## Current approach with a flat carbon price at £60/t

The baseline scenario ('Business as usual + Gas boiler + PVs') would be required to make a carbon offsetting contribution equivalent to approximately £14/m<sup>2</sup>.

## Our recommendation: a tiered carbon price

We recommend a tiered carbon price as follows:

- **£1,000/tCO<sub>2</sub> for residual emissions worse than a 60% improvement over Part L** as our analysis demonstrates that it is possible to achieve at least a 60% reduction with low carbon heat (e.g. heat pump system) and reasonable levels of fabric and ventilation performance. The high price would encourage applicants to consider this approach as 'the new business as usual'.
- **£300/tCO<sub>2</sub> for residual emissions comprised between a 60 and 80% improvement over Part L** to incentivise more savings from fabric and ventilation performance and/or more PVs: it would be cheaper to install more PVs than to pay into the offset fund.
- **£100/tCO<sub>2</sub> for residual emissions better than a 80 improvement over Part L** to signal that achieving an 80% improvement over Part L is a good achievement. To signal this even more strongly, the carbon price could even be reduced further.

As it can be seen on the adjacent graphs, changing the carbon price from the current £60/tCO<sub>2</sub> to our recommended tiered approach would increase the costs of the high carbon specifications. It would therefore successfully incentivise applicants to consider and implement lower carbon strategies.

## Additional costs and impact on viability

The most economic low carbon scenarios are 3B (Ultra-low energy + Direct electric + PVs) at £22/m<sup>2</sup> and 2C (Good practice + Heat pump + PVs) at £37/m<sup>2</sup>. This represents a total additional cost (construction + offsetting) of only £8-£23/m<sup>2</sup> compared to the baseline.

## Other approaches to the carbon offsetting price

- **Flat carbon price:** the flat carbon price approach would only be effective with a very high carbon offset price.
- **Stepped carbon price:** the stepped approach has the desired effect but creates some potential 'threshold' effects: a development's carbon offsetting contribution would triple if its residual emissions were to increase by a small margin, but above a threshold.

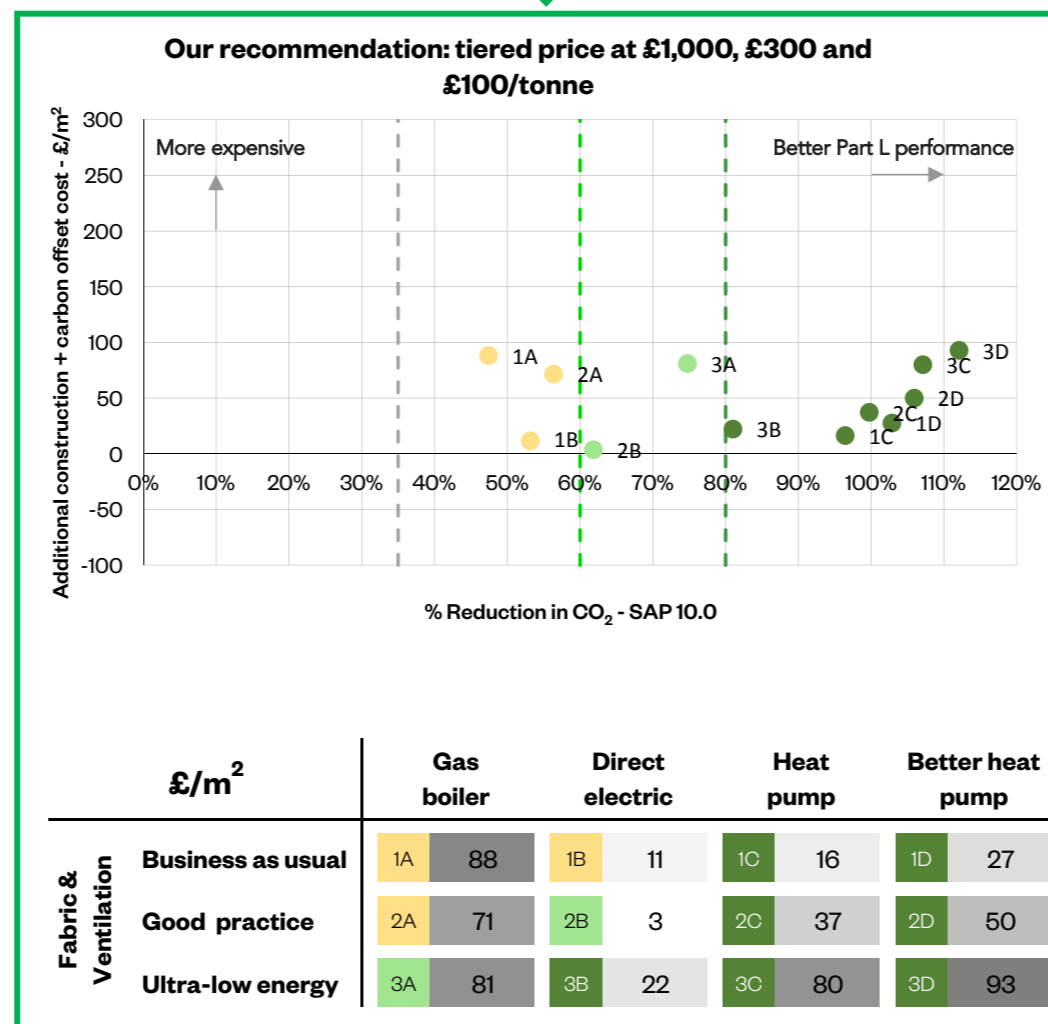
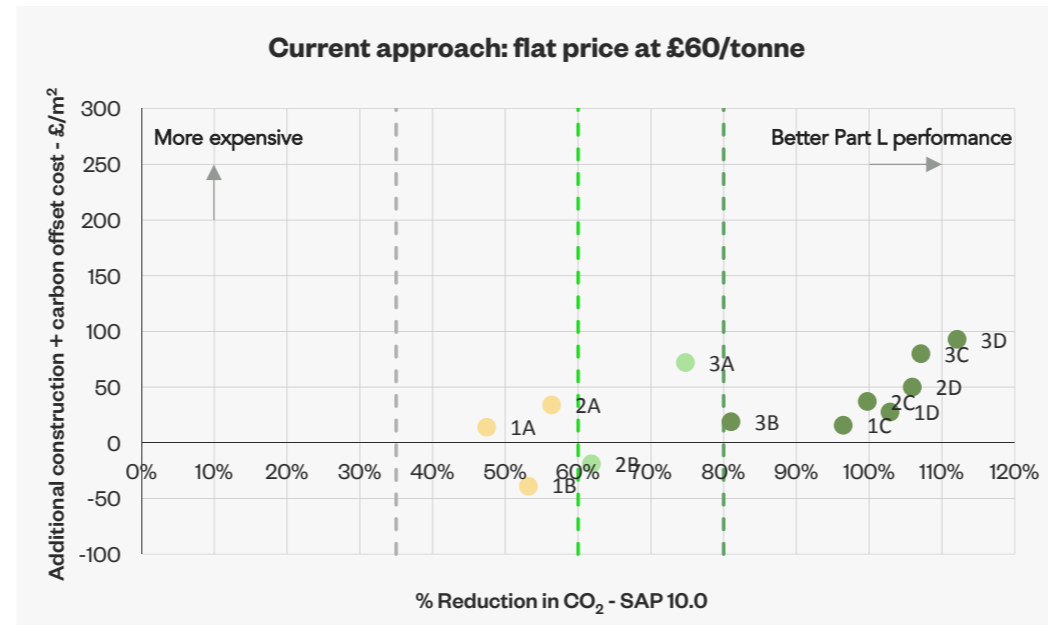

Table 22 - Terrace house – What would be the effect of the recommended tiered carbon price approach?

## Alternative approaches to carbon pricing (Not recommended)

### Flat carbon price (Terraced house)

Impact on additional cost + carbon offsetting cost

		Flat price £100/t £/m <sup>2</sup>			
		Gas boiler	Direct electric	Heat pump	Better heat pump
Fabric & Ventilation	Business as usual	23	-31	16	27
	Good practice	41	-13	37	50
	Ultra-low energy	76	22	80	93

		Flat price £300/t £/m <sup>2</sup>			
		Gas boiler	Direct electric	Heat pump	Better heat pump
Fabric & Ventilation	Business as usual	69	10	19	27
	Good practice	79	21	37	50
	Ultra-low energy	98	39	80	93

		Flat price £1,000/t £/m <sup>2</sup>			
		Gas boiler	Direct electric	Heat pump	Better heat pump
Fabric & Ventilation	Business as usual	229	153	30	27
	Good practice	213	137	38	50
	Ultra-low energy	175	96	80	93

### Stepped carbon price

		Stepped price £1,000, 300, 100/t - £/m <sup>2</sup>			
		Gas boiler	Direct electric	Heat pump	Better heat pump
Fabric & Ventilation	Business as usual	229	153	16	27
	Good practice	213	21	37	50
	Ultra-low energy	98	22	80	93



## Performance against 'be lean' requirement\*

Be Lean Reduction in CO <sub>2</sub> - SAP 10.0 (reg)		≥10% (draft London Plan requirement)
		Mid-rise apartment
Fabric & Ventilation	Business as usual	4%
	Good practice	15%
	Ultra-low energy	29%

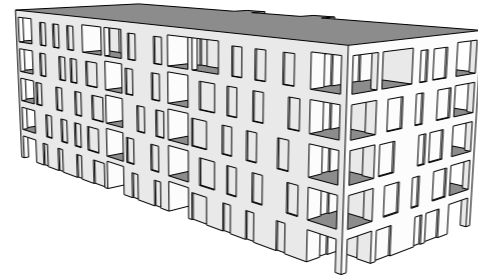

A 5-storey apartment building has been considered as a case study. Its floor area is 3,200 sqm GIA.

Only the 'Good practice' and 'Ultra-low energy' Fabric & Ventilation specifications comply with the minimum 'be lean' requirement for domestic buildings assuming the SAP 10.0 carbon factors. It is therefore effective at incentivising better levels of energy efficiency. The carbon offset price could be used to go further.

## What can technically be achieved with energy efficient fabric and services, and low carbon heat?

Focusing on the combinations that the planning system should incentivise, very significant improvements over Part L can be achieved on-site with the SAP 10.0 carbon factors (>65%). This demonstrates that the 35% Part L improvement on-site is not adequate for mid-rise apartment building. Unless policy can be changed, the carbon offset price should correct this.

## Impact of PVs

PVs are not necessary to achieve the minimum 35% improvement on-site. Unless the carbon offset price is higher than the cost of installing PVs, their inclusion in the design will not be incentivised. This should be considered.

## Impact of carbon factor

If the analysis is done using an estimate for the future carbon factor for electricity (i.e. 71 gCO<sub>2</sub>/kWh) instead of SAP 10 (i.e. 233 gCO<sub>2</sub>/kWh), the conclusions above remain the same.

\* Under the 'be lean' requirement of the new London Plan, residential buildings should achieve a minimum 10% improvement over Part L from energy efficiency alone (i.e. building fabric and ventilation).

Reduction in CO <sub>2</sub> - SAP 10.0 (reg)	With PV			
	Gas boiler	Direct electric	Heat pump	Better heat pump
Business as usual	26%	40%	71%	87%
Good practice	38%	51%	77%	91%
Ultra-low energy	51%	66%	86%	96%

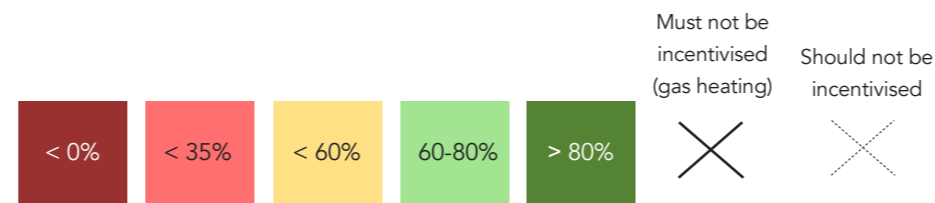

Table 23 - Mid-rise apartment building - Improvement over Part L assuming 233 gCO<sub>2</sub>/kWh (SAP 10) for grid-supplied electricity

Reduction in CO <sub>2</sub> - SAP 10.0 (reg)	With PV			
	Gas boiler	Direct electric	Heat pump	Better heat pump
Business as usual	26%	40%	71%	87%
Good practice	38%	51%	77%	91%
Ultra-low energy	51%	66%	86%	96%

PVs covering 50% of the roof

Reduction in CO <sub>2</sub> - SAP 10.0 (reg)	No PV			
	Gas boiler	Direct electric	Heat pump	Better heat pump
Business as usual	26%	18%	49%	66%
Good practice	38%	29%	55%	69%
Ultra-low energy	26%	44%	64%	75%

Table 24 - Mid-rise apartment building - Impact of PVs

Reduction in CO <sub>2</sub> - SAP 10.0 (reg)	With PV			
	Gas boiler	Direct electric	Heat pump	Better heat pump
Business as usual	26%	40%	71%	87%
Good practice	38%	51%	77%	91%
Ultra-low energy	51%	66%	86%	96%

Electricity carbon factor set at 233 gCO<sub>2</sub>/kWh (SAP 10)

Reduction in CO <sub>2</sub> - Future (reg)	With PV			
	Gas boiler	Direct electric	Heat pump	Better heat pump
Business as usual	18%	80%	90%	96%
Good practice	29%	83%	92%	97%
Ultra-low energy	4%	88%	95%	99%

Electricity carbon factor set at 71 gCO<sub>2</sub>/kWh (Estimate 2020-2050)

Table 25 - Mid-rise apartment building - Impact of changing the electricity carbon factor



## Construction costs

The baseline in terms of construction costs is the 'Business as usual + Gas boiler + PVs' scenario. This scenario is nearly compliant with the London Plan requirement of a minimum 35% carbon reduction over Part L but is not far (i.e. 26%).

The additional construction costs of the four lowest carbon options compared to this baseline are comprised between 3.4% and 6.8%.

This excludes any carbon offsetting cost.

It is important to note that this comparison is based on exactly the same design and does not include the cost reductions and efficiencies which can be achieved on a low energy design process (e.g. form factor).

## Development costs

The impact would be only between 1.4% and 2.7% if the whole development costs were considered.

## Additional construction cost vs Part L CO<sub>2</sub> reduction

The graph on the right hand side highlights the relationship between uplift in cost and reduction in carbon emissions.

### Notes on costs:

The uplift costs associated with each specification option were estimated based on Currie & Brown's cost datasets for energy efficiency and low carbon technologies which incorporate information from market prices obtained, specific market testing and first principles cost planning by their specialist quantity surveyors. The costs are based on Q3 2019 prices and reflect a London / South East cost base. Costs were developed for each affected element to identify the variance in price between the baseline and the enhanced specifications.

Those elements that are not materially affected by the energy efficiency / low carbon technology options, eg substructure, roof coverings, kitchen and bathrooms, etc, were not costed in detail. Instead these costs were incorporated within the 'balance of construction' cost was estimated by reference to a typical whole building construction cost per m<sup>2</sup> for the building type in question. This whole building cost was then adjusted for each option based on the variance in the elements costed in detail to determine the overall percentage impact on construction costs.

The potential impact on total development cost was estimated on the basis of the construction cost representing c.40% of the total development costs with the balance being comprised of land cost, finance and project fees and other planning requirements.

Reduction in CO <sub>2</sub> - SAP 10.0 (reg)		With PV			
		Gas boiler	Direct electric	Heat pump	Better heat pump
Fabric & Ventilation	Business as usual	26%	40%	71%	87%
	Good practice	38%	51%	77%	91%
	Ultra-low energy	51%	66%	86%	96%

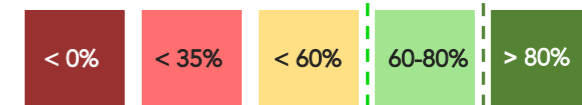

Table 26 - Mid-rise apartment building - Improvement over Part L assuming 233 gCO<sub>2</sub>/kWh (SAP 10) for grid-supplied electricity (Same table as previous page)

## Mid-rise apartment (~ £2,200/m<sup>2</sup> baseline construction cost)

% uplift in cost per m <sup>2</sup> of construction		With PV			
		Gas boiler	Direct electric	Heat pump	Better heat pump
Fabric & Ventilation	Business as usual	0%	-2.7%	1.6%	3.7%
	Good practice	1.8%	-0.9%	3.4%	5.5%
	Ultra-low energy	3.1%	0.4%	4.7%	6.8%

Table 27 - Mid-rise apartment building - Additional construction costs (£/m<sup>2</sup>) compared with the 'Business as usual + Gas boiler scenario + PVs' baseline scenario - Analysis by Currie & Brown

The four lowest carbon options are outlined

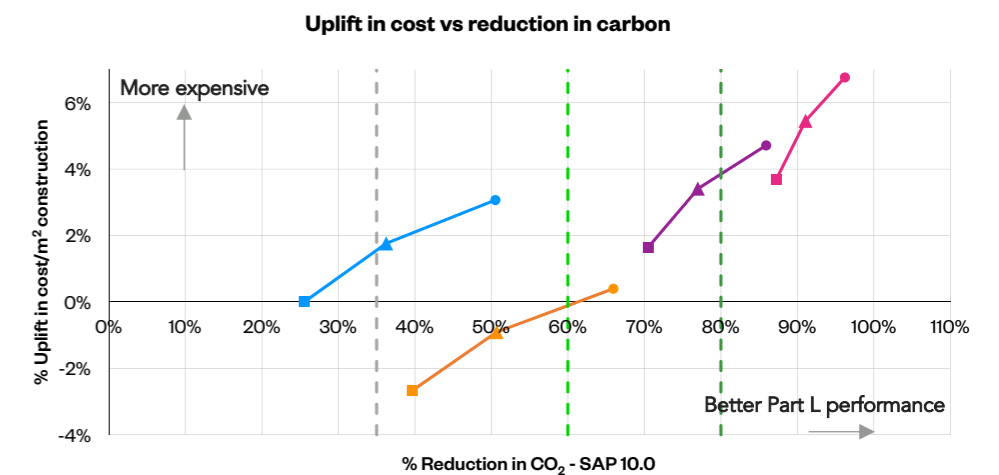

Figure 48 - Mid-rise apartment building - Additional construction costs vs Part L reduction based on system chosen

## Current approach with a flat carbon price at £60/t

The baseline scenario ('Business as usual + Gas boiler + PVs') would be required to make a carbon offsetting contribution equivalent to approximately £20/m<sup>2</sup>.

## Our recommendation: a tiered carbon price

We recommend a tiered carbon price as follows:

- **£1,000/tCO<sub>2</sub> for residual emissions worse than a 60% improvement over Part L** as our analysis demonstrates that it is possible to achieve at least a 60% reduction with low carbon heat (e.g. heat pump system) and reasonable levels of fabric and ventilation performance. The high price would encourage applicants to consider this approach as 'the new business as usual'.
- **£300/tCO<sub>2</sub> for residual emissions comprised between a 60 and 80% improvement over Part L** to incentivise more savings from fabric and ventilation performance and/or more PVs: it would be cheaper to install more PVs than to pay into the offset fund.
- **£100/tCO<sub>2</sub> for residual emissions better than a 80 improvement over Part L** to signal that achieving an 80% improvement over Part L is a good achievement. To signal this even more strongly, the carbon price could even be reduced further.

As it can be seen on the adjacent graphs, changing the carbon price from the current £60/tCO<sub>2</sub> to our recommended tiered approach would turn the cheapest and lowest performing specifications into the most expensive ones (or make their cost at least comparable to the low carbon alternatives). It would therefore successfully incentivise applicants to consider and implement lower carbon strategies.

## Additional costs and impact on viability

The most economic low carbon scenarios are 3B (Ultra-low energy + Direct electric + PVs) at £38/m<sup>2</sup>, 1C (Business as usual + Heat pump + PVs) at £59/m<sup>2</sup> and 2C (Good practice + Heat pump + PVs) at £89/m<sup>2</sup>. This represents a total additional cost (construction + offsetting) of £18-£69/m<sup>2</sup> compared to the baseline.

## Other approaches to the carbon offsetting price

- **Flat carbon price:** the flat carbon price approach would only be effective with a very high carbon offset price.
- **Stepped carbon price:** the stepped approach has the desired effect but creates some potential "threshold" effects: a development's carbon offsetting contribution would triple if its residual emissions were to increase by a small margin, but above a threshold.

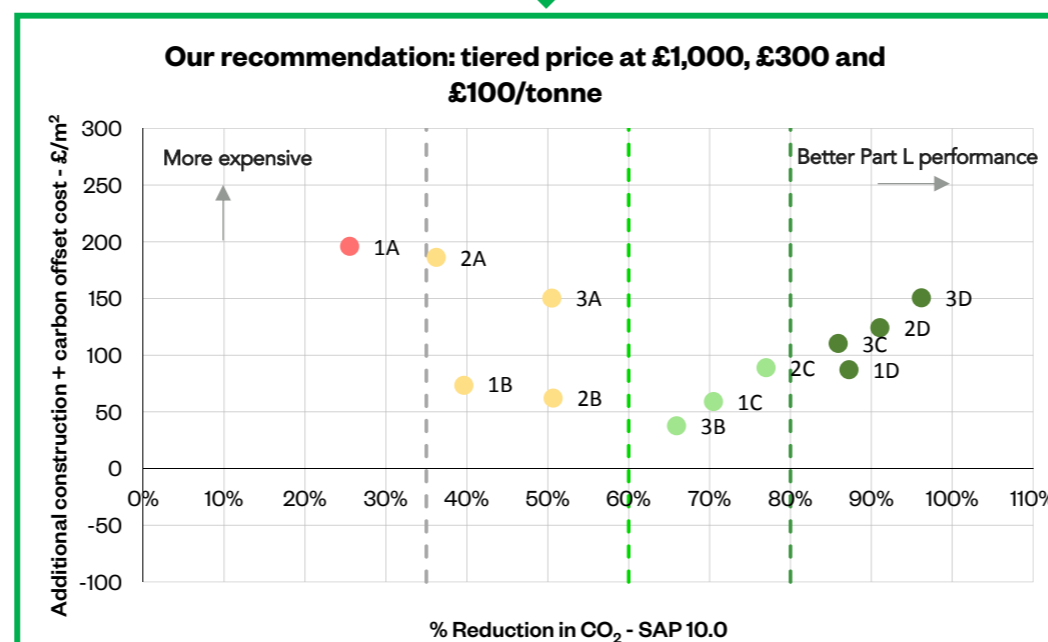
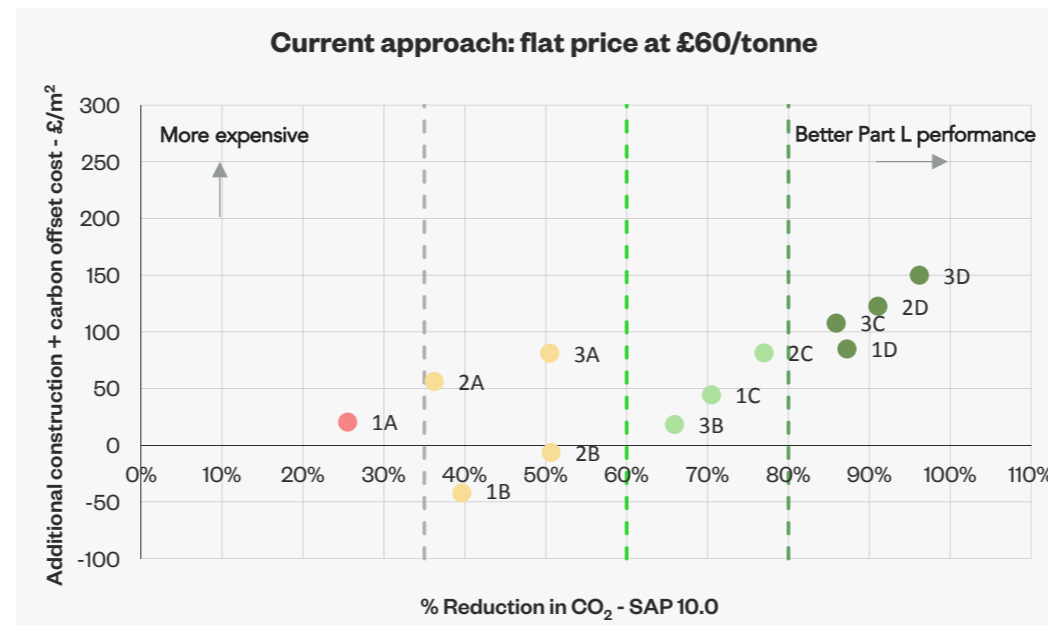

		£/m <sup>2</sup>							
		Gas boiler		Direct electric		Heat pump		Better heat pump	
Fabric & Ventilation	Business as usual	1A	196	1B	73	1C	59	1D	87
	Good practice	2A	186	2B	62	2C	89	2D	124
	Ultra-low energy	3A	150	3B	38	3C	110	3D	150

Table 28 - Mid-rise apartment building- What would be the effect of the recommended tiered carbon price approach?

## Alternative approaches to carbon pricing (Not recommended)

### Flat carbon price (Mid-rise apartment building) Impact on additional cost + carbon offsetting cost

Flat price £100/t £/m <sup>2</sup>		Gas boiler	Direct electric	Heat pump	Better heat pump
Fabric & Ventilation	Business as usual	34	-31	50	87
	Good practice	68	2	85	124
	Ultra-low energy	90	24	110	150

Flat price £300/t £/m <sup>2</sup>		Gas boiler	Direct electric	Heat pump	Better heat pump
Fabric & Ventilation	Business as usual	101	23	76	99
	Good practice	125	47	106	132
	Ultra-low energy	135	55	123	154

Flat price £1,000/t £/m <sup>2</sup>		Gas boiler	Direct electric	Heat pump	Better heat pump
Fabric & Ventilation	Business as usual	337	215	170	139
	Good practice	327	203	179	160
	Ultra-low energy	292	163	168	166

### Stepped carbon price

Stepped price £1,000, 300, 100/t - £/m <sup>2</sup>		Gas boiler	Direct electric	Heat pump	Better heat pump
Fabric & Ventilation	Business as usual	337	215	76	87
	Good practice	327	203	106	124
	Ultra-low energy	292	55	110	150

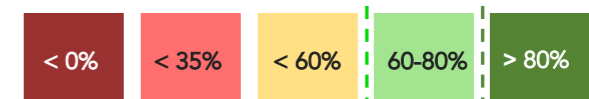

## Performance against 'be lean' requirement\*

Be Lean Reduction in CO <sub>2</sub> - SAP 10.0 (reg)		≥10% (draft London Plan requirement)
High-rise apartment		
Fabric & Ventilation	Business as usual	5%
	Good practice	15%
	Ultra-low energy	26%

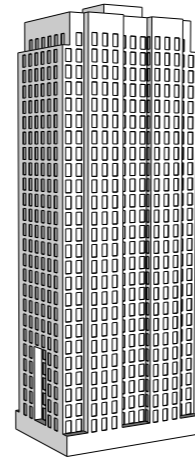

A 25-storey apartment building has been considered as a case study. Its floor area is 14,600 sqm GIA.

Only the 'Good practice' and 'Ultra-low energy' Fabric & Ventilation specifications comply with the minimum 'be lean' requirement for domestic buildings assuming the SAP 10 carbon factors. It is therefore effective at incentivising better levels of energy efficiency. The carbon offset price could be used to go further.

## What can technically be achieved with energy efficient fabric and services, and low carbon heat?

Focusing on the combinations that the planning system should incentivise, significant improvements over Part L can be achieved on-site with the SAP 10.0 carbon factors (>60%). This demonstrates that the 35% Part L improvement on-site is not adequate for high-rise apartment building. Unless policy can be changed, the carbon offset price should correct this.

Please note that the results are noticeably different from the Terrace house and Mid-rise apartment building.

## Impact of PVs

PVs are not necessary to achieve the minimum 35% improvement on-site. Unless the carbon offset price is higher than the cost of installing PVs, their inclusion in the design will not be incentivised. This should be considered, even if the PV potential for high-rise apartment building is less important than for low and mid-rise housing.

## Impact of carbon factor

If the analysis is done using an estimate for the future carbon factor for electricity (i.e. 71 gCO<sub>2</sub>/kWh) instead of SAP 10 (i.e. 233 gCO<sub>2</sub>/kWh), the conclusions above change significantly: a significant improvement over Part L (>80%) becomes achievable.

\* Under the 'be lean' requirement of the new London Plan, residential buildings should achieve a minimum 10% improvement over Part L from energy efficiency alone (i.e. building fabric and ventilation).

Fabric & Ventilation	Reduction in CO <sub>2</sub> - SAP 10.0 (reg)	With PV			
		Gas boiler	Direct electric	Heat pump	Better heat pump
Business as usual	8%	25%	54%	69%	
Good practice	18%	35%	60%	72%	
Ultra-low energy	26%	47%	67%	75%	

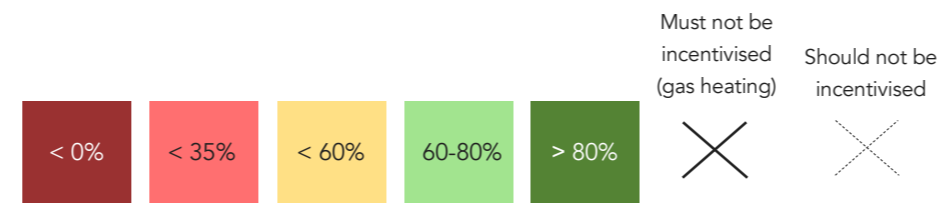

Table 29 - High-rise apartment building - Improvement over Part L assuming 233 gCO<sub>2</sub>/kWh (SAP 10.0) for grid-supplied electricity

Fabric & Ventilation	Reduction in CO <sub>2</sub> - SAP 10.0 (reg)	With PV PVs covering 50% of the roof			
		Gas boiler	Direct electric	Heat pump	Better heat pump
Business as usual	8%	25%	54%	69%	
Good practice	18%	35%	60%	72%	
Ultra-low energy	26%	47%	67%	75%	

Fabric & Ventilation	Reduction in CO <sub>2</sub> - SAP 10.0 (reg)	No PV			
		Gas boiler	Direct electric	Heat pump	Better heat pump
Business as usual	8%	22%	51%	66%	
Good practice	18%	32%	57%	68%	
Ultra-low energy	26%	44%	64%	72%	

Table 30 - High-rise apartment building - Impact of PVs

Fabric & Ventilation	Reduction in CO <sub>2</sub> - SAP 10.0 (reg)	With PV Electricity carbon factor set at 233 gCO <sub>2</sub> /kWh (SAP 10.0)			
		Gas boiler	Direct electric	Heat pump	Better heat pump
Business as usual	8%	25%	54%	69%	
Good practice	18%	35%	60%	72%	
Ultra-low energy	26%	47%	67%	75%	

Fabric & Ventilation	Reduction in CO <sub>2</sub> - Future (reg)	With PV Electricity carbon factor set at 71 gCO <sub>2</sub> /kWh (Estimate 2020-2050)			
		Gas boiler	Direct electric	Heat pump	Better heat pump
Business as usual	14%	75%	84%	90%	
Good practice	23%	78%	86%	90%	
Ultra-low energy	32%	82%	89%	92%	

Table 31 - High-rise apartment building - Impact of changing the electricity carbon factor



## Construction costs

The baseline in terms of construction costs is the 'Business as usual + Gas boiler + PVs' scenario. This scenario is not compliant with the London Plan requirement of a minimum 35% carbon reduction over Part L.

The additional construction costs of the four lowest carbon options compared to this baseline are comprised between 2.4% and 4.6%.

This excludes any carbon offsetting cost.

It is important to note that this comparison is based on exactly the same design and does not include the cost reductions and efficiencies which can be achieved on a low energy design process (e.g. form factor).

## Development costs

The impact would be only between 1.0% and 1.9% if the whole development costs were considered.

## Additional construction cost vs Part L CO<sub>2</sub> reduction

The graph on the right hand side highlights the relationship between uplift in cost and reduction in carbon emissions.

### Notes on costs:

The uplift costs associated with each specification option were estimated based on Currie & Brown's cost datasets for energy efficiency and low carbon technologies which incorporate information from market prices obtained, specific market testing and first principles cost planning by their specialist quantity surveyors. The costs are based on Q3 2019 prices and reflect a London / South East cost base. Costs were developed for each affected element to identify the variance in price between the baseline and the enhanced specifications.

Those elements that are not materially affected by the energy efficiency / low carbon technology options, eg substructure, roof coverings, kitchen and bathrooms, etc, were not costed in detail. Instead these costs were incorporated within the 'balance of construction' cost was estimated by reference to a typical whole building construction cost per m<sup>2</sup> for the building type in question. This whole building cost was then adjusted for each option based on the variance in the elements costed in detail to determine the overall percentage impact on construction costs.

The potential impact on total development cost was estimated on the basis of the construction cost representing c.40% of the total development costs with the balance being comprised of land cost, finance and project fees and other planning requirements.

Reduction in CO <sub>2</sub> - SAP 10.0 (reg)		With PV			
		Gas boiler	Direct electric	Heat pump	Better heat pump
Fabric & Ventilation	Business as usual	8%	25%	54%	69%
	Good practice	18%	35%	60%	72%
	Ultra-low energy	28%	47%	67%	75%

Table 32 - High-rise apartment building - Improvement over Part L assuming 233 gCO<sub>2</sub>/kWh (SAP 10) for grid-supplied electricity (Same table as previous page)

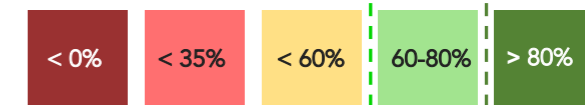

## High-rise apartment (~ £3,100/m<sup>2</sup> baseline construction cost)

% uplift in cost per m <sup>2</sup> of construction		With PV			
		Gas boiler	Direct electric	Heat pump	Better heat pump
Fabric & Ventilation	Business as usual	0.0%	-1.9%	1.2%	2.6%
	Good practice	1.2%	-0.7%	2.4%	3.8%
	Ultra-low energy	2.8%	0.1%	3.2%	4.6%

Table 33 - High-rise apartment building - Additional construction costs (£/m<sup>2</sup>) compared with the 'Business as usual + Gas boiler scenario + PVs' baseline scenario - Analysis by Currie & Brown

The four lowest carbon options are outlined

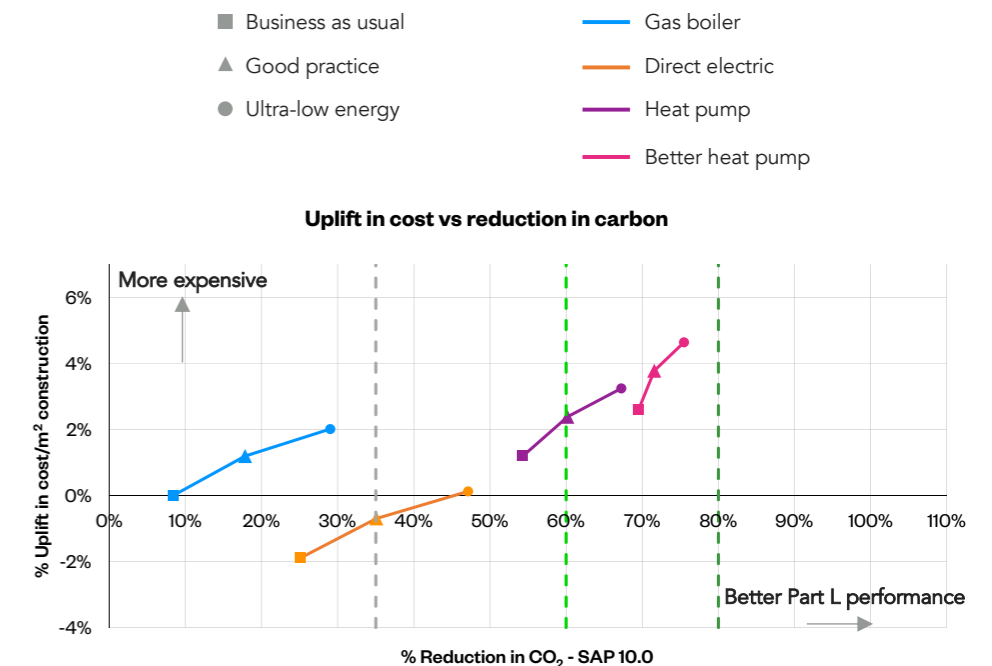

Figure 49 - High-rise apartment building - Additional construction costs vs Part L reduction

## Current approach with a flat carbon price at £60/t

The baseline scenario ('Business as usual + Gas boiler + PVs') would be required to make a carbon offsetting contribution equivalent to approximately £24/m<sup>2</sup>.

## Our recommendation: a tiered carbon price

We recommend a tiered carbon price as follows:

- **£1,000/tCO<sub>2</sub> for residual emissions worse than a 60% improvement over Part L** as our analysis demonstrates that it is possible to achieve at least a 60% reduction with low carbon heat (e.g. heat pump system) and reasonable levels of fabric and ventilation performance. The high price would encourage applicants to consider this approach as 'the new business as usual'.
- **£300/tCO<sub>2</sub> for residual emissions comprised between a 60 and 80% improvement over Part L** to incentivise more savings from fabric and ventilation performance and/or more PVs: it would be cheaper to install more PVs than to pay into the offset fund.
- **£100/tCO<sub>2</sub> for residual emissions better than a 80 improvement over Part L** to signal that achieving an 80% improvement over Part L is a good achievement. To signal this even more strongly, the carbon price could even be reduced further.

As it can be seen on the adjacent graphs, changing the carbon price from the current £60/tCO<sub>2</sub> to our recommended tiered approach would turn the cheapest and lowest performing specifications into the most expensive ones (or make their cost at least comparable to the low carbon alternatives). It would therefore successfully incentivise applicants to consider and implement lower carbon strategies.

## Additional costs and impact on viability

The most economic low carbon scenario are 2C (Good practice + Heat pump + PVs) at £109/m<sup>2</sup> and 1D (Business as usual + Better heat pump + PVs) at £103/m<sup>2</sup>. **This represents a total additional cost (construction + offsetting) of £79-85/m<sup>2</sup> compared to the baseline.**

## Other approaches to the carbon offsetting price

- **Flat carbon price:** the flat carbon price approach has a significant disadvantage: it requires a high price to be effective but then adds a significant carbon offsetting cost to the best performing specifications.
- **Stepped carbon price:** the stepped approach has the desired effect but creates some potential "threshold" effects: a development's carbon offsetting contribution would triple if its residual emissions were to increase by a small margin, but above a threshold.

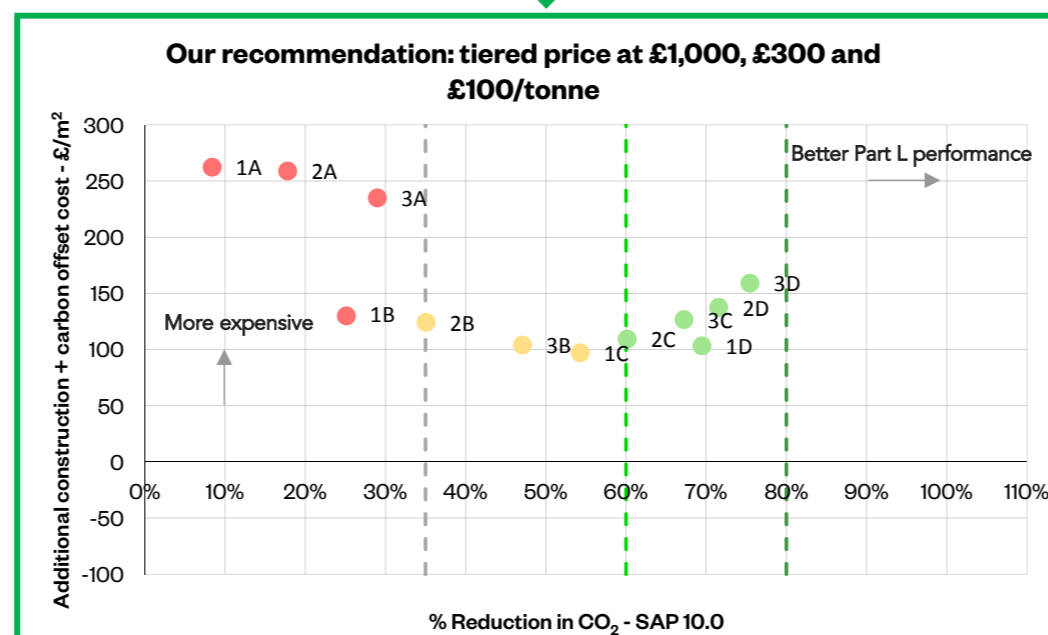
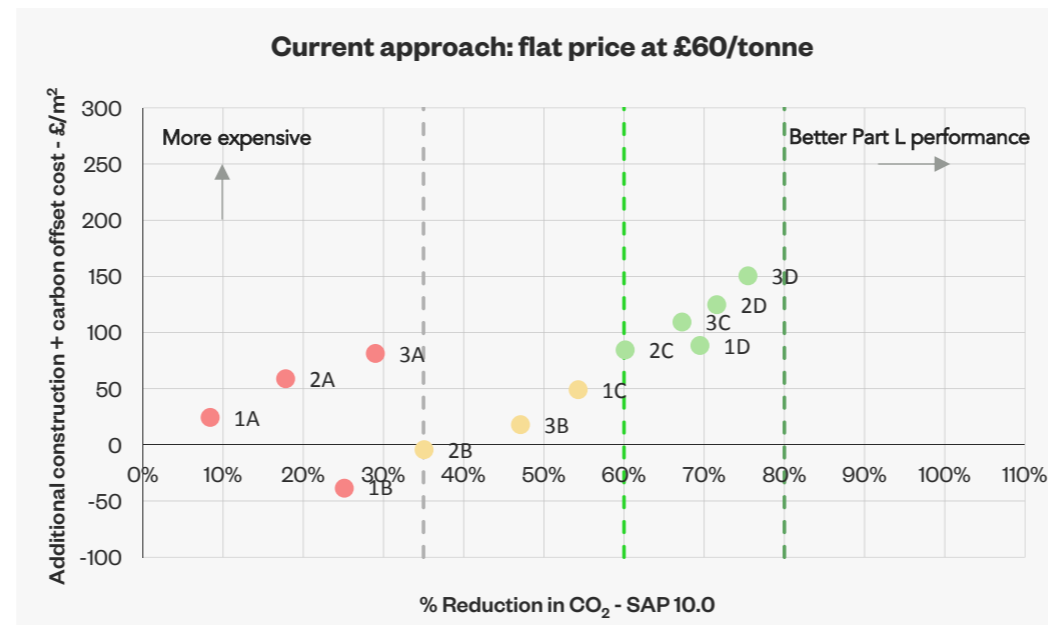

		£/m <sup>2</sup>							
		Gas boiler		Direct electric		Heat pump		Better heat pump	
Fabric & Ventilation	Business as usual	1A	262	1B	130	1C	97	1D	103
	Good practice	2A	259	2B	124	2C	109	2D	137
	Ultra-low energy	3A	235	3B	104	3C	127	3D	159

Table 34 – High-rise – What would be the effect of the recommended tiered carbon price approach?

## Alternative approaches to carbon pricing (Not recommended)

### Flat carbon price (High-rise apartment building) Impact on additional cost + carbon offsetting cost

		Flat price £100/t £/m <sup>2</sup>			
		Gas boiler	Direct electric	Heat pump	Better heat pump
Fabric & Ventilation	Business as usual	40	-26	57	94
	Good practice	73	7	91	130
	Ultra-low energy	94	27	115	155

		Flat price £300/t £/m <sup>2</sup>			
		Gas boiler	Direct electric	Heat pump	Better heat pump
Fabric & Ventilation	Business as usual	121	40	97	120
	Good practice	146	64	127	155
	Ultra-low energy	156	74	144	176

		Flat price £1,000/t £/m <sup>2</sup>			
		Gas boiler	Direct electric	Heat pump	Better heat pump
Fabric & Ventilation	Business as usual	403	271	238	215
	Good practice	400	265	250	243
	Ultra-low energy	376	238	245	252

### Stepped carbon price

		Stepped price £1,000, 300, 100/t - £/m <sup>2</sup>			
		Gas boiler	Direct electric	Heat pump	Better heat pump
Fabric & Ventilation	Business as usual	403	271	238	120
	Good practice	400	265	127	155
	Ultra-low energy	376	238	144	176

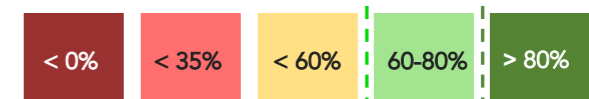

## Performance against 'be lean' requirement\*

Be Lean Reduction in CO <sub>2</sub> - SAP 10.0 (reg)		≥15% <i>(draft London Plan requirement)</i>
Hotel		
Fabric & Ventilation	Business as usual	-4%
	Good practice	1%
	Ultra-low energy	5%

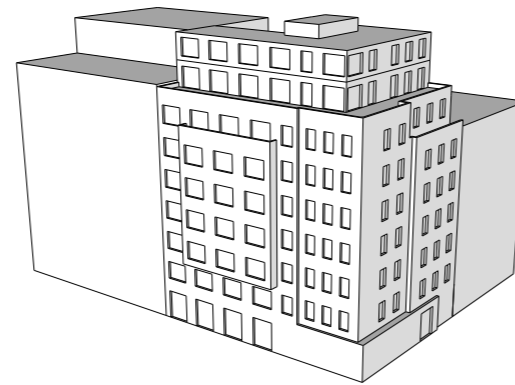

A 9-storey hotel has been considered as a case study. Its floor area is 3,600 sqm GIA.

None of the Fabric & Ventilation specifications comply with the minimum 'be lean' requirement for non-domestic buildings assuming the SAP 10.0 carbon factors. It is therefore unlikely to be complied with. The carbon offset price could be used to incentivise energy efficiency.

## What can technically be achieved with energy efficient fabric and services, and low carbon heat?

Focusing on the combinations that the planning system should incentivise, significant improvements over Part L can be achieved on-site with the SAP 10.0 carbon factors (>45%). The carbon offset price should incentivise this.

## Impact of PVs

PVs are not necessary to achieve the minimum 35% improvement on-site. Unless the carbon offset price is higher than the cost of installing PVs, their inclusion in the design will not be incentivised. This should be considered, even if the PV potential for high-rise apartment building is less important than for low and mid-rise housing.

## Impact of carbon factor

If the analysis is done using an estimate for the future carbon factor for electricity (i.e. 71 gCO<sub>2</sub>/kWh) instead of SAP 10.0 (i.e. 233 gCO<sub>2</sub>/kWh), the conclusions above change very significantly: a significant improvement over Part L (>80%) becomes achievable.

\* Under the 'be lean' requirement of the new London Plan, hotels should achieve a minimum 15% improvement over Part L from energy efficiency alone (i.e. building fabric and ventilation).

Reduction in CO <sub>2</sub> - SAP 10.0 (reg)		With PV			
		Gas boiler	VRF	Heat pump	Better heat pump
Fabric & Ventilation	Business as usual	2%	56%	45%	56%
	Good practice	7%	58%	48%	58%
	Ultra-low energy	11%	61%	51%	61%

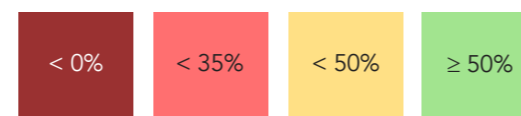

Must not be incentivised (gas heating) Should not be incentivised

Table 35 - Hotel - Improvement over Part L assuming 233 gCO<sub>2</sub>/kWh (SAP 10.0) for grid-supplied electricity

Reduction in CO <sub>2</sub> - SAP 10.0 (reg)		With PV			
		Gas boiler	VRF	Heat pump	Better heat pump
Fabric & Ventilation	Business as usual	2%	56%	45%	56%
	Good practice	7%	58%	48%	58%
	Ultra-low energy	11%	61%	51%	61%

PVs covering 50% of the roof

Reduction in CO <sub>2</sub> - SAP 10.0 (reg)		No PV			
		Gas boiler	VRF	Heat pump	Better heat pump
Fabric & Ventilation	Business as usual	2%	53%	43%	53%
	Good practice	7%	56%	46%	56%
	Ultra-low energy	11%	58%	48%	58%

Table 36 - Hotel - Impact of PVs

Reduction in CO <sub>2</sub> - SAP 10.0 (reg)		With PV			
		Gas boiler	VRF	Heat pump	Better heat pump
Fabric & Ventilation	Business as usual	2%	56%	45%	56%
	Good practice	7%	58%	48%	58%
	Ultra-low energy	11%	61%	51%	61%

Electricity carbon factor set at 233 gCO<sub>2</sub>/kWh (SAP 10.0)

Reduction in CO <sub>2</sub> - Future (reg)		With PV			
		Gas boiler	VRF	Heat pump	Better heat pump
Fabric & Ventilation	Business as usual	2%	84%	80%	84%
	Good practice	8%	85%	81%	85%
	Ultra-low energy	10%	86%	82%	86%

Electricity carbon factor set at 71 gCO<sub>2</sub>/kWh (Estimate 2020-2050)

Table 37 - Hotel - Impact of changing the electricity carbon factor



## Construction costs

The baseline in terms of construction costs is the 'Business as usual + Gas boiler + PVs' scenario. This scenario is not compliant with the London Plan requirement of a minimum 35% carbon reduction over Part L.

The additional construction costs of the four lowest carbon options compared to this baseline are comprised between 3.0% and 6.7%.

This excludes any carbon offsetting cost.

It is important to note that this comparison is based on exactly the same design and does not include the cost reductions and efficiencies which can be achieved on a low energy design process (e.g. form factor).

## Development costs

The impact would be only between 1.2% and 2.7% if the whole development costs were considered.

## Additional construction cost vs Part L CO<sub>2</sub> reduction

The graph on the right hand side highlights the relationship between uplift in cost and reduction in carbon emissions.

### Notes on costs:

The uplift costs associated with each specification option were estimated based on Currie & Brown's cost datasets for energy efficiency and low carbon technologies which incorporate information from market prices obtained, specific market testing and first principles cost planning by their specialist quantity surveyors. The costs are based on Q3 2019 prices and reflect a London / South East cost base. Costs were developed for each affected element to identify the variance in price between the baseline and the enhanced specifications.

Those elements that are not materially affected by the energy efficiency / low carbon technology options, eg substructure, roof coverings, kitchen and bathrooms, etc, were not costed in detail. Instead these costs were incorporated within the 'balance of construction' cost was estimated by reference to a typical whole building construction cost per m<sup>2</sup> for the building type in question. This whole building cost was then adjusted for each option based on the variance in the elements costed in detail to determine the overall percentage impact on construction costs.

The potential impact on total development cost was estimated on the basis of the construction cost representing c.40% of the total development costs with the balance being comprised of land cost, finance and project fees and other planning requirements.

Reduction in CO <sub>2</sub> - SAP 10.0 (reg)		With PV			
		Gas boiler	VRF	Heat pump	Better heat pump
Fabric & Ventilation	Business as usual	2%	56%	45%	56%
	Good practice	7%	58%	48%	58%
	Ultra-low energy	11%	61%	51%	61%

Table 38 - Hotel - Improvement over Part L assuming 233 gCO<sub>2</sub>/kWh (SAP 10.0) for grid-supplied electricity (Same table as previous page)

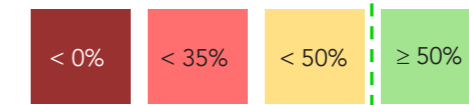

## Hotel (~ £3,800/m<sup>2</sup> baseline construction cost)

% uplift in cost per m <sup>2</sup> of construction		With PV			
		Gas boiler	VRF	Heat pump	Better heat pump
Fabric & Ventilation	Business as usual	0%	-3.1%	1.1%	6.5%
	Good practice	2.8%	-0.1%	3.0%	6.9%
	Ultra-low energy	3.2%	1.3%	3.7%	6.7%

Table 39 - Hotel - Additional construction costs (£/m<sup>2</sup>) compared with the 'Business as usual + Gas boiler scenario + PVs' baseline scenario - Analysis by Currie & Brown

The four lowest carbon options are outlined

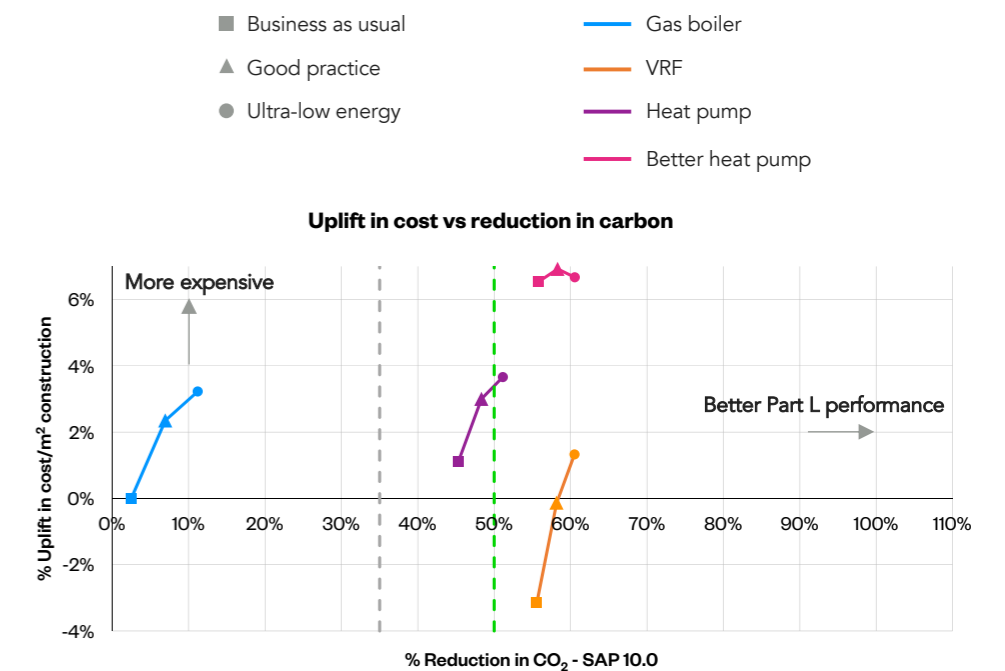

Figure 50 - Hotel - Additional construction costs vs Part L reduction

## Current approach with a flat carbon price at £60/t

The baseline scenario ('Business as usual + Gas boiler + PVs') would be required to make a carbon offsetting contribution equivalent to approximately £77/m<sup>2</sup>.

## Our recommendation: a tiered carbon price

We recommend a tiered carbon price as follows:

- **£1,000/tCO<sub>2</sub> for residual emissions worse than a 50% improvement over Part L** as our analysis demonstrates that it is possible to achieve at least a 50% reduction with low carbon heat (e.g. heat pump system) and reasonable levels of fabric and ventilation performance. The high price would encourage applicants to consider this approach as 'the new business as usual'.
- **£300/tCO<sub>2</sub> for residual emissions equal or better than a 50% improvement over Part L** to incentivise more savings from fabric and ventilation performance and/or more PVs: it would be cheaper to install more PVs than to pay into the offset fund.

Contrary to the domestic buildings, there is no clear reason to 'signal' an exemplar level of residual regulated emissions (e.g. 80%) as the evidence does not suggest one. This is largely due to the fact that Part L2A modelling significantly underestimates the differences between scenarios.

As it can be seen on the adjacent graphs, changing the carbon price from the current £60/tCO<sub>2</sub> to our recommended tiered approach would turn the cheapest and lowest performing specifications into the most expensive ones. It would therefore successfully incentivise applicants to consider and implement lower carbon strategies.

## Additional costs and impact on viability

The most economic low carbon scenario is 1B (Business as usual + VRF + PVs) at £55/m<sup>2</sup>. This represents a **saving of £22/m<sup>2</sup>** in terms of total additional cost (construction + offsetting) compared to the baseline.

## Other approaches to the carbon offsetting price

- **Flat carbon price:** the flat carbon price approach has a significant disadvantage: it requires a high price to be effective but then adds a significant carbon offsetting cost to the best performing specifications.
- **Stepped carbon price:** the stepped approach does not have the desired effect due to the small difference in Part L performance between the scenarios.

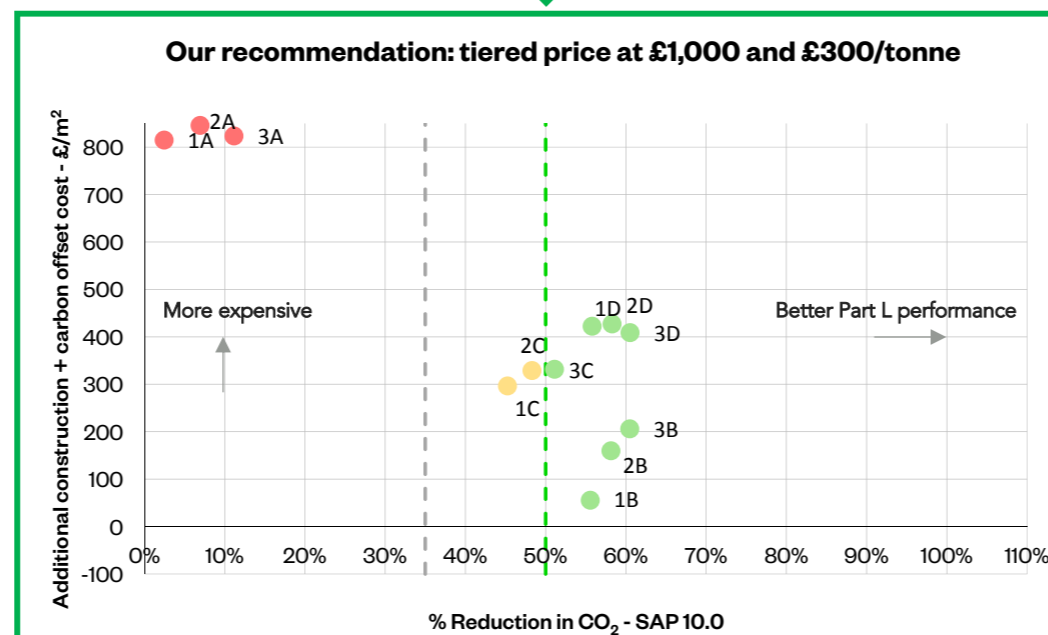
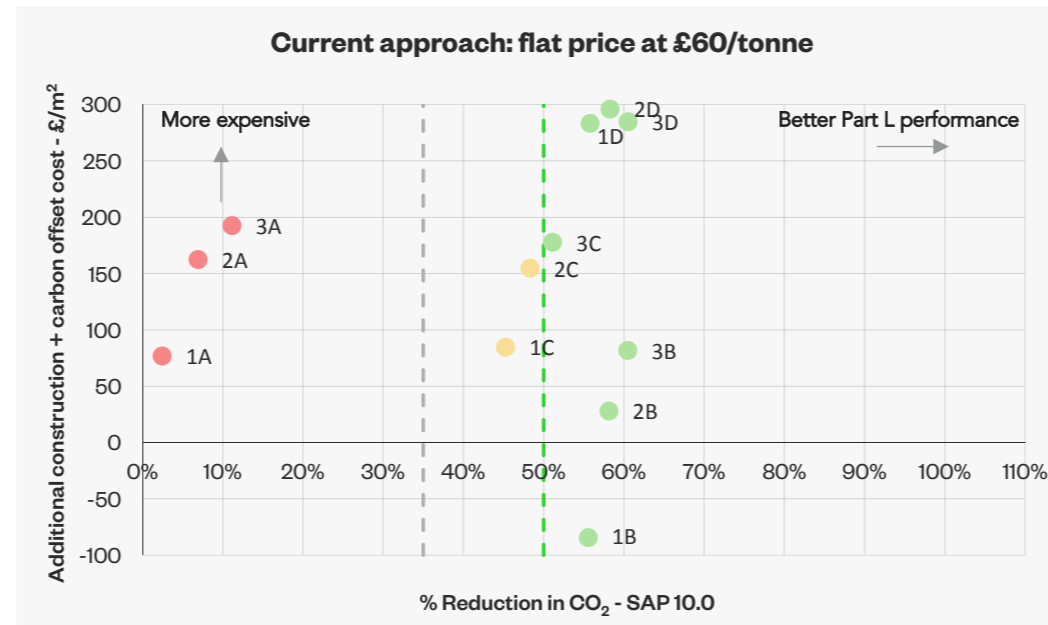

		£/m <sup>2</sup>		Gas boiler		VRF		Heat pump		Better heat pump	
Fabric & Ventilation	Business as usual	1A	815	1B	55	1C	296	1D	422		
	Good practice	2A	845	2B	159	2C	329	2D	427		
	Ultra-low energy	3A	823	3B	206	3C	331	3D	408		

Table 40 - Hotel – What would be the effect of the recommended tiered carbon price approach?

## Alternative approaches to carbon pricing (Not recommended)

### Flat carbon price (Mid-rise apartment building) Impact on additional cost + carbon offsetting cost

		Flat price £100/t £/m <sup>2</sup>		Gas boiler		VRF		Heat pump		Better heat pump	
Fabric & Ventilation	Business as usual			128	-61	113	306				
	Good practice			211	50	182	318				
	Ultra-low energy			239	102	203	305				

		Flat price £300/t £/m <sup>2</sup>		Gas boiler		VRF		Heat pump		Better heat pump	
Fabric & Ventilation	Business as usual			383	55	256	422				
	Good practice			455	159	317	427				
	Ultra-low energy			471	206	331	408				

		Flat price £1,000/t £/m <sup>2</sup>		Gas boiler		VRF		Heat pump		Better heat pump	
Fabric & Ventilation	Business as usual			1277	462	758	827				
	Good practice			1307	543	791	809				
	Ultra-low energy			1285	567	779	770				

### Stepped carbon price

		Stepped price £1,000, 300/t - £/m <sup>2</sup>		Gas boiler		VRF		Heat pump		Better heat pump	
Fabric & Ventilation	Business as usual			1277	55	758	422				
	Good practice			1307	159	791	427				
	Ultra-low energy			1285	206	331	408				

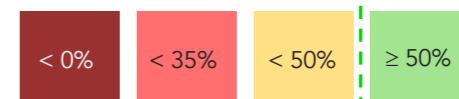

## Performance against 'be lean' requirement

Be Lean Reduction in CO <sub>2</sub> - SAP 10.0 (reg)		≥15% (draft London Plan requirement)
<b>School</b>		
Fabric & Ventilation	Business as usual	7%
	Good practice	0%
	Ultra-low energy	8%

The results get worse as Part L penalises 'good practice' MVHR against extract only ventilation

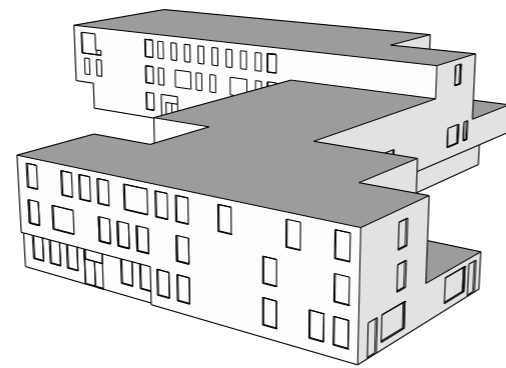

A 3/4 storey school has been considered as a case study. Its floor area is 6,000 sqm GIA.

None of the Fabric & Ventilation specifications comply with the minimum 'be lean' requirement for non-domestic buildings assuming the SAP 10.0 carbon factors. It is therefore unlikely to be complied with. The carbon offset price could be used to incentivise energy efficiency.

The table above also shows one of the issues with Part L2A modelling: as it underestimates space heating demand it also underestimates the benefit of Mechanical Ventilation with Heat Recovery (Good Practice and Ultra-low energy).

## What can technically be achieved with energy efficient fabric and services, and low carbon heat?

Focusing on the combinations that the planning system should incentivise, significant improvements over Part L can be achieved **on-site** with the SAP 10.0 carbon factors (>45%). The carbon offset price should incentivise this.

Reduction in CO <sub>2</sub> - SAP 10.0 (reg)		With PV			
		Gas boiler	Direct electric	Heat pump	Better heat pump
Fabric & Ventilation	Business as usual	48%	50%	58%	62%
	Good practice	48%	46%	47%	47%
	Ultra-low energy	51%	53%	53%	54%

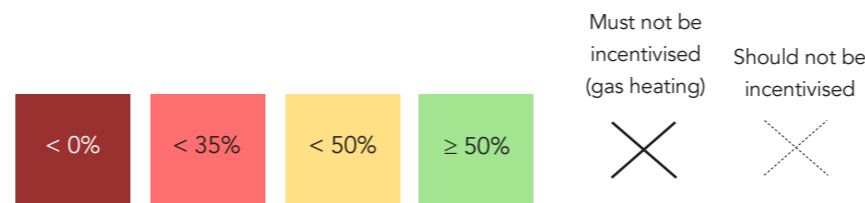

Table 41 - School - Improvement over Part L assuming 233 gCO<sub>2</sub>/kWh (SAP 10.0) for grid-supplied electricity

## Impact of PVs

PVs appear to be necessary for the school to comply with the minimum 35% improvement on-site. Ensuring that the carbon offset price is higher than the additional cost of adding more PVs would incentivise greater savings on-site. This should be considered, especially PVs would help reduce schools' energy bills.

## Impact of carbon factor

If the analysis is done using an estimate for the future carbon factor for electricity (i.e. 71 gCO<sub>2</sub>/kWh) instead of SAP 10.0 (i.e. 233 gCO<sub>2</sub>/kWh), the conclusions above change significantly: a significant improvement over Part L (>75%) becomes achievable.

\* Under the 'be lean' requirement of the new London Plan, schools should achieve a minimum 15% improvement over Part L from energy efficiency alone (i.e. building fabric and ventilation).

Reduction in CO <sub>2</sub> - SAP 10.0 (reg)		With PV			
		Gas boiler	Direct electric	Heat pump	Better heat pump
Fabric & Ventilation	Business as usual	48%	50%	58%	62%
	Good practice	48%	46%	47%	47%
	Ultra-low energy	51%	53%	53%	54%

PVs covering 50% of the roof

Reduction in CO <sub>2</sub> - SAP 10.0 (reg)		No PV			
		Gas boiler	Direct electric	Heat pump	Better heat pump
Fabric & Ventilation	Business as usual	12%	15%	23%	28%
	Good practice	9%	8%	8%	8%
	Ultra-low energy	14%	14%	14%	14%

Table 42 - School - Impact of PVs

Reduction in CO <sub>2</sub> - SAP 10.0 (reg)		With PV			
		Gas boiler	Direct electric	Heat pump	Better heat pump
Fabric & Ventilation	Business as usual	48%	50%	58%	62%
	Good practice	48%	46%	47%	47%
	Ultra-low energy	51%	53%	53%	54%

Electricity carbon factor set at 233 gCO<sub>2</sub>/kWh (SAP 10.0)

Reduction in CO <sub>2</sub> - Future (reg)		With PV			
		Gas boiler	Direct electric	Heat pump	Better heat pump
Fabric & Ventilation	Business as usual	28%	79%	82%	84%
	Good practice	28%	74%	75%	75%
	Ultra-low energy	28%	78%	78%	78%

Electricity carbon factor set at 71 gCO<sub>2</sub>/kWh (Estimate 2020-2050)

Table 43 - School - Impact of changing the electricity carbon factor



## Construction costs

The baseline in terms of construction costs is the 'Business as usual + Gas boiler + PVs' scenario. This scenario is compliant with the London Plan requirement of a minimum 35% carbon reduction over Part L.

The additional construction costs of the four lowest carbon options compared to this baseline are comprised between 2.7% and 4.3%.

This excludes any carbon offsetting cost.

It is important to note that this comparison is based on exactly the same design and does not include the cost reductions and efficiencies which can be achieved on a low energy design process (e.g. form factor).

## Development costs

The impact would be only between 1.1% and 1.7% if the whole development costs were considered.

## Additional construction cost vs Part L CO<sub>2</sub> reduction

The graph on the right hand side highlights the relationship between uplift in cost and reduction in carbon emissions.

### Notes on costs:

The uplift costs associated with each specification option were estimated based on Currie & Brown's cost datasets for energy efficiency and low carbon technologies which incorporate information from market prices obtained, specific market testing and first principles cost planning by their specialist quantity surveyors. The costs are based on Q3 2019 prices and reflect a London / South East cost base. Costs were developed for each affected element to identify the variance in price between the baseline and the enhanced specifications.

Those elements that are not materially affected by the energy efficiency / low carbon technology options, eg substructure, roof coverings, kitchen and bathrooms, etc, were not costed in detail. Instead these costs were incorporated within the 'balance of construction' cost was estimated by reference to a typical whole building construction cost per m<sup>2</sup> for the building type in question. This whole building cost was then adjusted for each option based on the variance in the elements costed in detail to determine the overall percentage impact on construction costs.

The potential impact on total development cost was estimated on the basis of the construction cost representing c.40% of the total development costs with the balance being comprised of land cost, finance and project fees and other planning requirements.

Reduction in CO <sub>2</sub> - SAP 10.0 (reg)		With PV			
		Gas boiler	Direct electric	Heat pump	Better heat pump
Fabric & Ventilation	Business as usual	48%	50%	58%	62%
	Good practice	43%	46%	47%	47%
	Ultra-low energy	51%	53%	53%	54%

Table 44 - School - Improvement over Part L assuming 233 gCO<sub>2</sub>/kWh (SAP 10.0) for grid-supplied electricity (Same table as previous page)

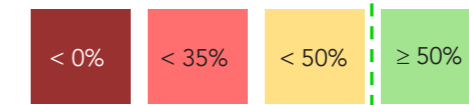

## School (~ £3,000/m<sup>2</sup> baseline construction cost)

% uplift in cost per m <sup>2</sup> of construction		With PV			
		Gas boiler	Direct electric	Heat pump	Better heat pump
Fabric & Ventilation	Business as usual	0%	-2.0%	1.1%	4.5%
	Good practice	2.2%	0.5%	2.7%	4.6%
	Ultra-low energy	3.6%	2.1%	3.6%	4.3%

Table 45 - School - Additional construction costs (£/m<sup>2</sup>) compared with the 'Business as usual + Gas boiler scenario + PVs' baseline scenario - Analysis by Currie & Brown

The four lowest carbon options are outlined

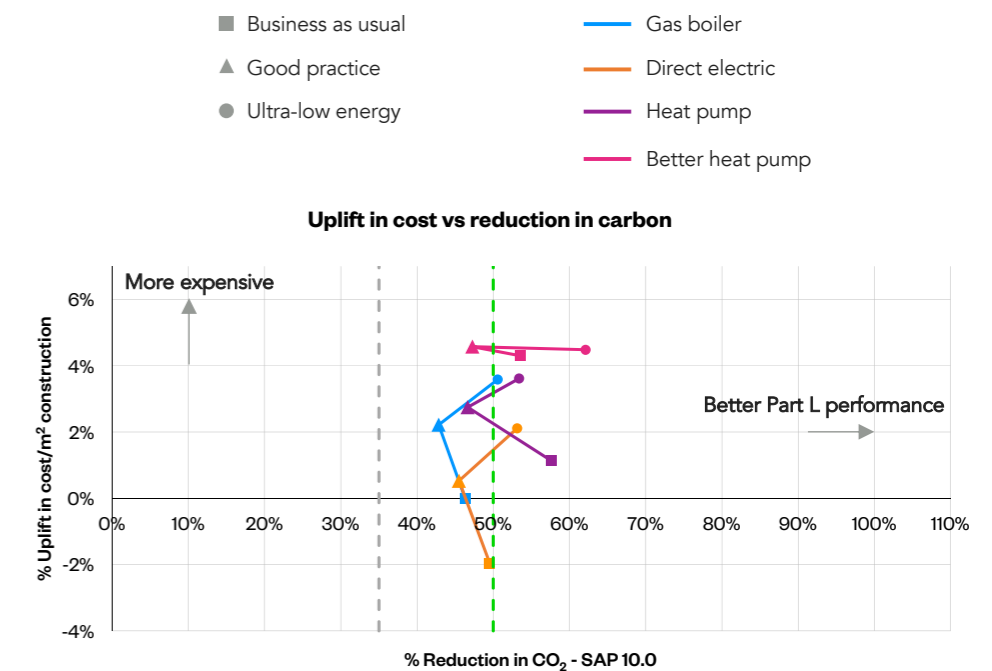

Figure 51 - School - Additional construction costs vs Part L reduction

## Current approach with a flat carbon price at £60/t

The baseline scenario ('Business as usual + Gas boiler + PVs') would be required to make a carbon offsetting contribution equivalent to approximately £10/m<sup>2</sup>.

## Our recommendation: a tiered carbon price

We recommend a tiered carbon price as follows:

- **£1,000/tCO<sub>2</sub> for residual emissions worse than a 50% improvement over Part L** as our analysis demonstrates that it is possible to achieve at least a 50% reduction with low carbon heat (e.g. heat pump system) and reasonable levels of fabric and ventilation performance. The high price would encourage applicants to consider this approach as 'the new business as usual'.
- **£300/tCO<sub>2</sub> for residual emissions equal or better than a 50% improvement over Part L** to incentivise more savings from fabric and ventilation performance and/or more PVs: it would be cheaper to install more PVs than to pay into the offset fund.

Contrary to the domestic buildings, there is no clear reason to 'signal' an exemplar level of residual regulated emissions (e.g. 80%) as the evidence does not suggest one. This is largely due to the fact that Part L2A modelling significantly underestimates the differences between scenarios.

As it can be seen on the adjacent graphs, changing the carbon price from the current £60/tCO<sub>2</sub> to our recommended tiered approach would help to incentivise applicants to consider and implement lower carbon strategies. However, it also shows that due to the issue associated with Part L2A modelling, it does not help significantly.

## Additional costs and impact on viability

The most economic low carbon scenario is 1C (Business as usual + Heat pump + PVs) at £72/m<sup>2</sup>. This represents a total additional cost (construction + offsetting) of £62/m<sup>2</sup> compared to the baseline.

## Other approaches to the carbon offsetting price

- **Flat carbon price:** the flat carbon price approach has a significant disadvantage: it requires a high price to be effective but then adds a significant carbon offsetting cost to the best performing specifications.
- **Stepped carbon price:** the stepped approach does not have the desired effect due to the small difference in Part L performance between the scenarios.

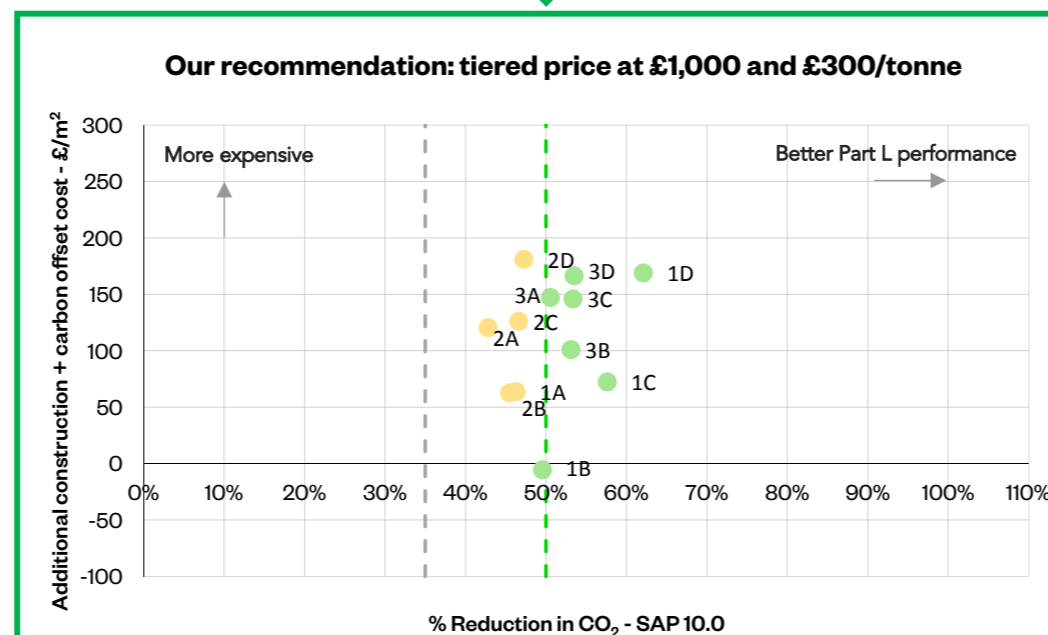
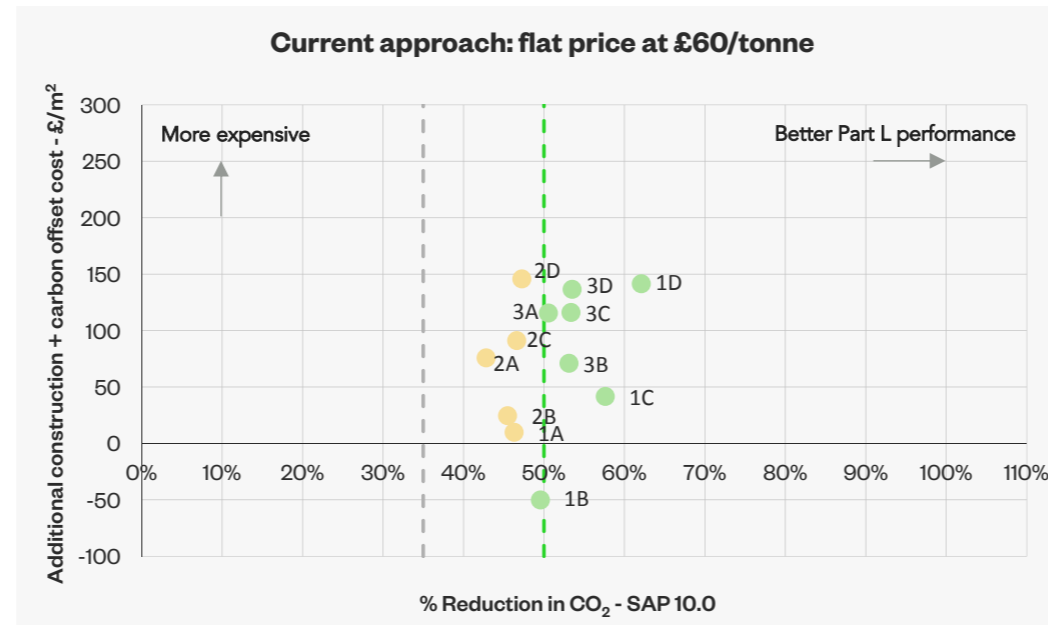

		£/m <sup>2</sup>		Gas boiler		Direct electric		Heat pump		Better heat pump	
Fabric & Ventilation	<b>Business as usual</b>	1A	64	1B	-6	1C	72	1D	169		
	<b>Good practice</b>	2A	120	2B	62	2C	126	2D	181		
	<b>Ultra-low energy</b>	3A	147	3B	101	3C	146	3D	166		

Table 47 - School – What would be the effect of the recommended tiered carbon price approach?

## Alternative approaches to carbon pricing (Not recommended)

### Flat carbon price (Mid-rise apartment building) Impact on additional cost + carbon offsetting cost

		Flat price £100/t £/m <sup>2</sup>		Gas boiler		Direct electric		Heat pump		Better heat pump	
Fabric & Ventilation	<b>Business as usual</b>			16	-44	47	146				
	<b>Good practice</b>			82	30	97	151				
	<b>Ultra-low energy</b>			121	76	121	141				

		Flat price £300/t £/m <sup>2</sup>		Gas boiler		Direct electric		Heat pump		Better heat pump	
Fabric & Ventilation	<b>Business as usual</b>			49	-14	72	169				
	<b>Good practice</b>			112	59	125	179				
	<b>Ultra-low energy</b>			147	101	146	166				

		Flat price £1,000/t £/m <sup>2</sup>		Gas boiler		Direct electric		Heat pump		Better heat pump	
Fabric & Ventilation	<b>Business as usual</b>			162	93	162	249				
	<b>Good practice</b>			219	161	225	278				
	<b>Ultra-low energy</b>			239	188	233	253				

### Stepped carbon price

		Stepped price £1,000, 300/t - £/m <sup>2</sup>		Gas boiler		Direct electric		Heat pump		Better heat pump	
Fabric & Ventilation	<b>Business as usual</b>			162	93	72	169				
	<b>Good practice</b>			219	161	225	179				
	<b>Ultra-low energy</b>			147	101	146	166				

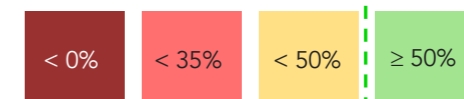

## Performance against 'be lean' requirement

Be Lean Reduction in CO <sub>2</sub> - SAP 10.0 (reg)		≥15% (draft London Plan requirement)
Office		
Fabric & Ventilation	Business as usual	5%
	Good practice	17%
	Ultra-low energy	31%

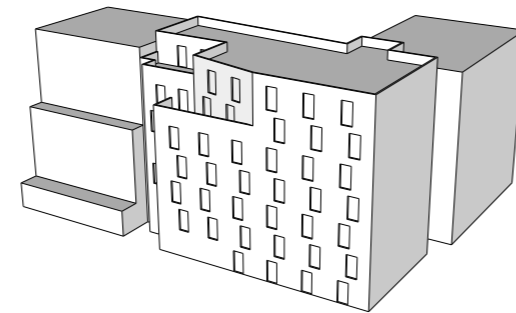

A 7-storey office has been considered as a case study. Its floor area is 4,000 sqm GIA.

Only the 'Good practice' and 'Ultra-low energy' Fabric & Ventilation specifications comply with the minimum 'be lean' requirement for domestic buildings assuming the SAP 10.0 carbon factors. It is therefore effective at incentivising better levels of energy efficiency. However, given the range of performance possible, the carbon offset price could be used to incentivise better specifications.

## What can technically be achieved with energy efficient fabric and services, and low carbon heat?

Focusing on the combinations that the planning system should incentivise, significant improvements over Part L can be achieved **on-site** with the SAP 10 carbon factors (>50%). The carbon offset price should incentivise this.

## Impact of PVs

PVs appear to be necessary for the office to comply with the minimum 35% improvement on-site except for the 'Ultra-low energy' scenario. Ensuring that the carbon offset price is higher than the additional cost of adding more PVs would incentivise greater savings on-site rather than the minimum required to achieve the 35% improvement.

## Impact of carbon factor

If the analysis is done using an estimate for the future carbon factor for electricity (i.e. 71 gCO<sub>2</sub>/kWh) instead of SAP 100. (i.e. 233 gCO<sub>2</sub>/kWh), **the conclusions above change slightly**: a significant improvement over Part L (>65%) becomes achievable.

\* Under the 'be lean' requirement of the new London Plan, office buildings should achieve a minimum 15% improvement over Part L from energy efficiency alone (i.e. building fabric and ventilation).

Reduction in CO <sub>2</sub> - SAP 10.0 (reg)	With PV			
	Gas boiler	VRF	Heat pump	Better heat pump
Business as usual	28%	48%	44%	49%
Good practice	41%	54%	51%	55%
Ultra-low energy	55%	61%	59%	61%

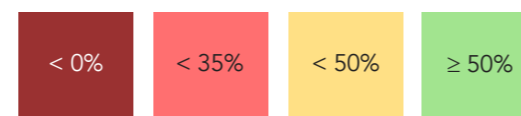

Must not be incentivised (gas heating) Should not be incentivised

Table 48 - Office (new build) - Improvement over Part L assuming 233 gCO<sub>2</sub>/kWh (SAP 10.0) for grid-supplied electricity

Reduction in CO <sub>2</sub> - SAP 10.0 (reg)	With PV			
	Gas boiler	VRF	Heat pump	Better heat pump
Business as usual	28%	48%	44%	49%
Good practice	41%	54%	51%	55%
Ultra-low energy	55%	61%	59%	61%

PVs covering 50% of the roof

Reduction in CO <sub>2</sub> - SAP 10.0 (reg)	No PV			
	Gas boiler	VRF	Heat pump	Better heat pump
Business as usual	8%	28%	24%	29%
Good practice	26%	34%	31%	34%
Ultra-low energy	34%	40%	39%	40%

Table 49 - Office (new build) - Impact of PVs

Reduction in CO <sub>2</sub> - SAP 10.0 (reg)	With PV			
	Gas boiler	VRF	Heat pump	Better heat pump
Business as usual	28%	48%	44%	49%
Good practice	41%	54%	51%	55%
Ultra-low energy	55%	61%	59%	61%

Electricity carbon factor set at 233 gCO<sub>2</sub>/kWh (SAP 10.0)

Reduction in CO <sub>2</sub> - Future (reg)	With PV			
	Gas boiler	VRF	Heat pump	Better heat pump
Business as usual	12%	65%	62%	66%
Good practice	38%	69%	67%	69%
Ultra-low energy	58%	73%	72%	73%

Electricity carbon factor set at 71 gCO<sub>2</sub>/kWh (Estimate 2020-2050)

Table 50 - Office (new build) - Impact of changing the electricity carbon factor



## Construction costs

The baseline in terms of construction costs is the 'Business as usual + Gas boiler + PVs' scenario. This scenario is almost compliant with the London Plan requirement of a minimum 35% carbon reduction over Part L (i.e. 29%).

The additional construction costs of the four lowest carbon options compared to a this baseline are comprised between 3.2% and 6.1%.

This excludes any carbon offsetting cost.

It is important to note that this comparison is based on exactly the same design and does not include the cost reductions and efficiencies which can be achieved on a low energy design process (e.g. form factor).

## Development costs

The impact would be only between 0.8% and 2.1% if the whole development costs were considered.

## Additional construction cost vs Part L CO<sub>2</sub> reduction

The graph on the right hand side highlights the relationship between uplift in cost and reduction in carbon emissions.

		Reduction in CO <sub>2</sub> - SAP 10.0 (reg)	With PV			
			Gas boiler	VRF	Heat pump	Better heat pump
Fabric & Ventilation	Business as usual	<del>29%</del>	48%	44%	49%	
	Good practice	<del>41%</del>	54%	51%	55%	
	Ultra-low energy	<del>55%</del>	61%	59%	61%	

Table 51 - Office (new build) - Improvement over Part L assuming 233 gCO<sub>2</sub>/kWh (SAP 10) for grid-supplied electricity (Same table as previous page)

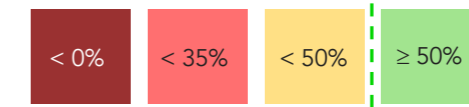

## Office (~ £3,600/m<sup>2</sup> baseline construction cost)

		% uplift in cost per m <sup>2</sup> of construction	With PV			
			Gas boiler	VRF	Heat pump	Better heat pump
Fabric & Ventilation	Business as usual	<del>0.8%</del>	-2.0%	0.6%	3.8%	
	Good practice	<del>2.8%</del>	1.2%	3.2%	5.6%	
	Ultra-low energy	<del>4.2%</del>	2.9%	4.4%	6.1%	

Table 52 - Office (new build) - Additional construction costs (£/m<sup>2</sup>) compared with the 'Business as usual + Gas boiler scenario + PVs' baseline scenario - Analysis by Currie & Brown

The four lowest carbon options are outlined

### Notes on costs:

The uplift costs associated with each specification option were estimated based on Currie & Brown's cost datasets for energy efficiency and low carbon technologies which incorporate information from market prices obtained, specific market testing and first principles cost planning by their specialist quantity surveyors. The costs are based on Q3 2019 prices and reflect a London / South East cost base. Costs were developed for each affected element to identify the variance in price between the baseline and the enhanced specifications.

Those elements that are not materially affected by the energy efficiency / low carbon technology options, eg substructure, roof coverings, kitchen and bathrooms, etc, were not costed in detail. Instead these costs were incorporated within the 'balance of construction' cost was estimated by reference to a typical whole building construction cost per m<sup>2</sup> for the building type in question. This whole building cost was then adjusted for each option based on the variance in the elements costed in detail to determine the overall percentage impact on construction costs.

The potential impact on total development cost was estimated on the basis of the construction cost representing c.40% of the total development costs with the balance being comprised of land cost, finance and project fees and other planning requirements.

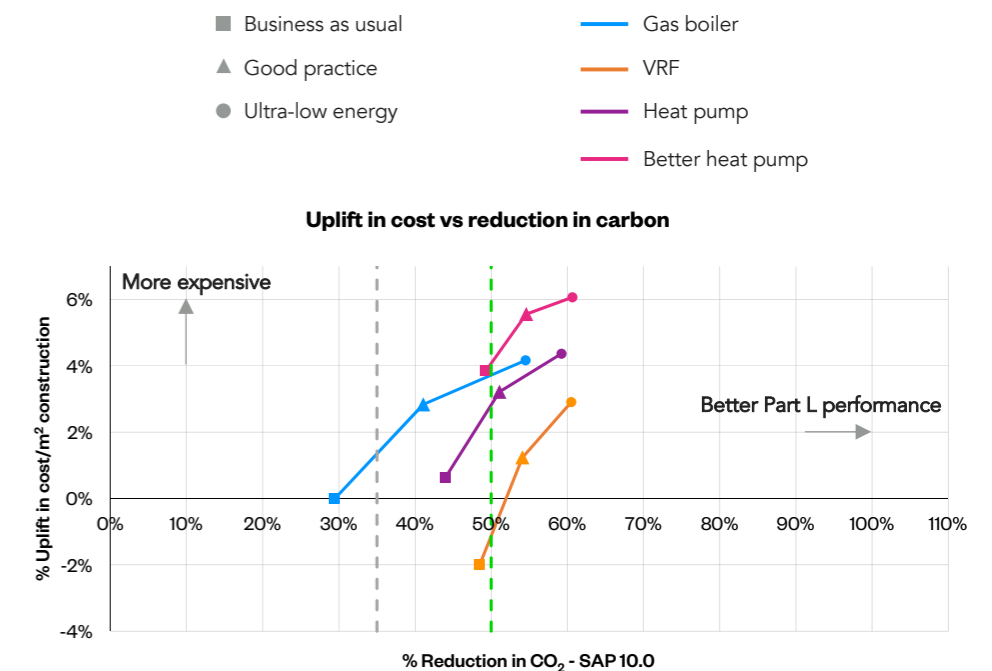

Figure 52- Office (new build) - Additional construction costs vs Part L reduction

## Current approach with a flat carbon price at £60/t

The baseline scenario ('Business as usual + Gas boiler + PVs') would be required to make a carbon offsetting contribution equivalent to approximately £12/m<sup>2</sup>.

## Our recommendation: a tiered carbon price

We recommend a tiered carbon price as follows:

- **£1,000/tCO<sub>2</sub> for residual emissions worse than a 50% improvement over Part L** as our analysis demonstrates that it is possible to achieve at least a 50% reduction with low carbon heat (e.g. heat pump system) and reasonable levels of fabric and ventilation performance. The high price would encourage applicants to consider this approach as 'the new business as usual'.
- **£300/tCO<sub>2</sub> for residual emissions equal or better than a 50% improvement over Part L** to incentivise more savings from fabric and ventilation performance and/or more PVs: it would be cheaper to install more PVs than to pay into the offset fund.

Contrary to the domestic buildings, there is no clear reason to 'signal' an exemplar level of residual regulated emissions (e.g. 80%) as the evidence does not suggest one. This is largely due to the fact that Part L2A modelling significantly underestimates the differences between scenarios.

As it can be seen on the adjacent graphs, changing the carbon price from the current £60/tCO<sub>2</sub> to our recommended tiered approach would help to incentivise applicants to consider and implement lower carbon strategies. However, it also shows that due to the issue associated with Part L2A modelling, it does not help significantly.

## Additional costs and impact on viability

The most economic low carbon scenario is 2B (Good practice + VRF + PVs) at £83/m<sup>2</sup>. This represents a total additional cost (construction + offsetting) of £71/m<sup>2</sup> compared to the baseline.

## Other approaches to the carbon offsetting price

- **Flat carbon price:** the flat carbon price approach has a significant disadvantage: it requires a high price to be effective but then adds a significant carbon offsetting cost to the best performing specifications.
- **Stepped carbon price:** the stepped approach does not have the desired effect due to the small difference in Part L performance between the scenarios.

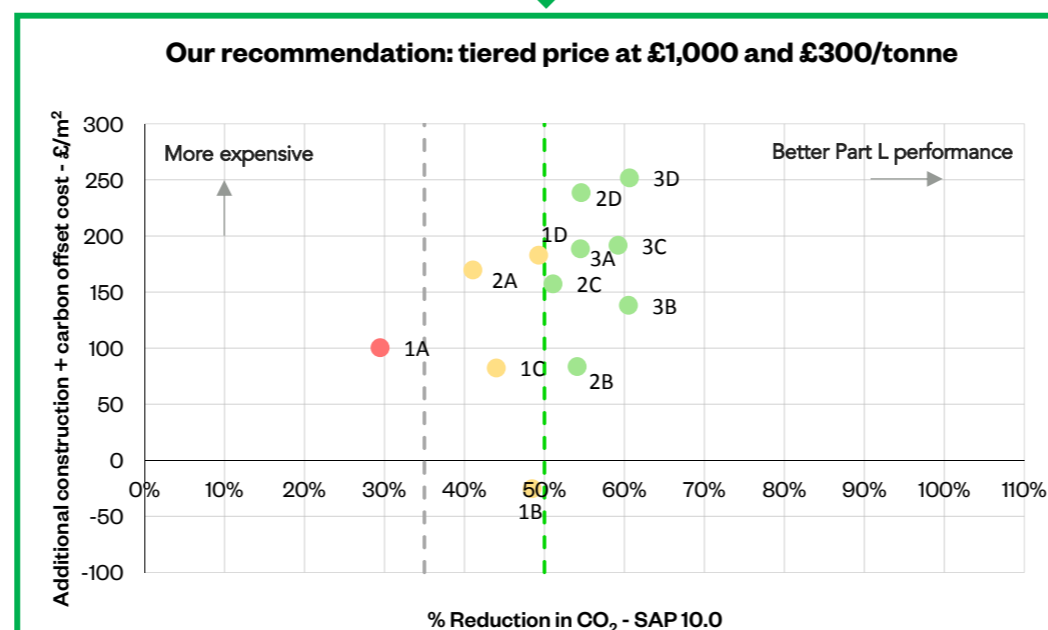
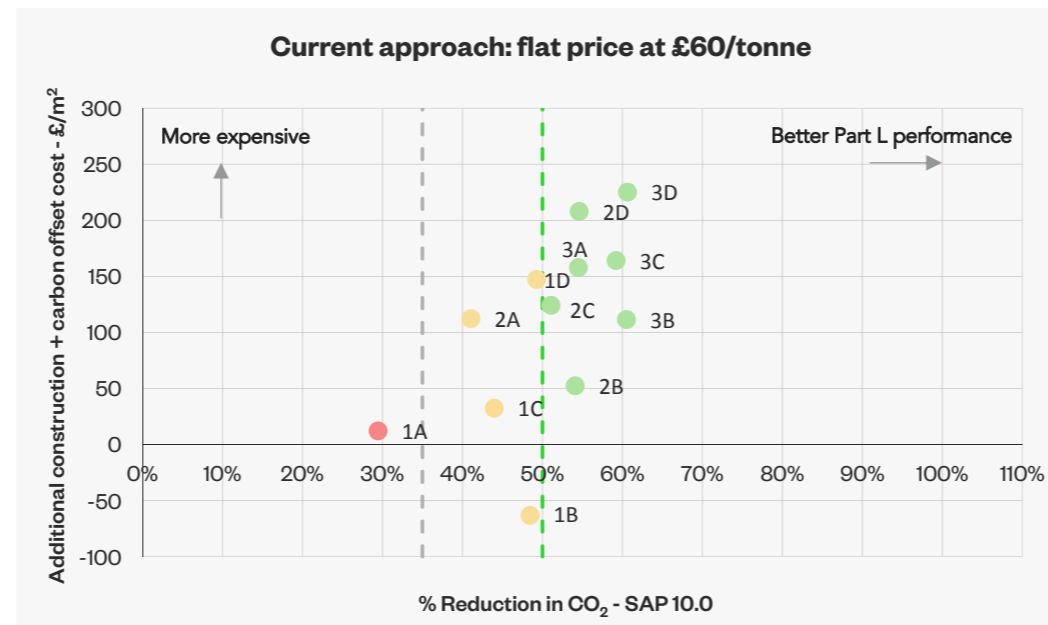

		£/m <sup>2</sup>		Gas boiler		VRF		Heat pump		Better heat pump	
Fabric & Ventilation	Business as usual	1A	100	1B	-26	1C	82	1D	183		
	Good practice	2A	170	2B	83	2C	157	2D	238		
	Ultra-low energy	3A	188	3B	138	3C	192	3D	252		

Table 54 - Office (new build) – What would be the effect of the recommended tiered carbon price approach?

## Alternative approaches to carbon pricing (Not recommended)

### Flat carbon price (Mid-rise apartment building) Impact on additional cost + carbon offsetting cost

Flat price £100/t £/m <sup>2</sup>		Gas boiler	VRF	Heat pump	Better heat pump
Fabric & Ventilation	Business as usual	20	-58	39	153
	Good practice	119	57	129	213
	Ultra-low energy	163	116	169	229

Flat price £300/t £/m <sup>2</sup>		Gas boiler	VRF	Heat pump	Better heat pump
Fabric & Ventilation	Business as usual	60	-29	70	181
	Good practice	152	83	157	238
	Ultra-low energy	188	138	192	252

Flat price £1,000/t £/m <sup>2</sup>		Gas boiler	VRF	Heat pump	Better heat pump
Fabric & Ventilation	Business as usual	199	73	181	281
	Good practice	268	174	254	328
	Ultra-low energy	278	216	272	329

### Stepped carbon price

Stepped price £1,000, 300/t - £/m <sup>2</sup>		Gas boiler	VRF	Heat pump	Better heat pump
Fabric & Ventilation	Business as usual	199	73	181	281
	Good practice	268	83	157	238
	Ultra-low energy	188	138	192	252

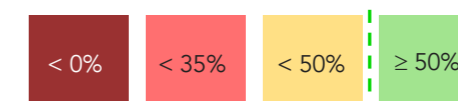

## Performance against 'be lean' requirement

Be Lean Reduction in CO <sub>2</sub> - SAP 10.0 (reg)		(no London Plan requirement)	
	Office refurb	Office refurb - existing	
Fabric & Ventilation	Business as usual	46%	30%
	Good practice	74%	n/a
	Ultra-low energy	83%	n/a

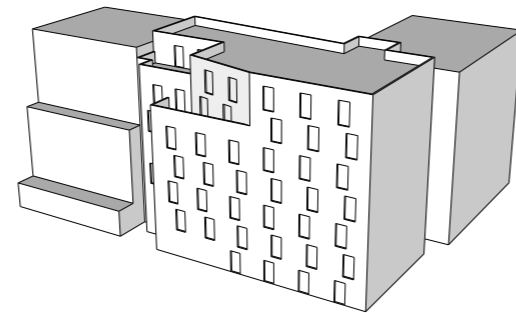

A 7-storey office has been considered as a case study. Its floor area is 4,000 sqm GIA.

There is no 'be lean' requirement for refurbishment. If there was one, a minimum 30% improvement on existing could be required. In any case, the carbon offset price could be used to incentivise better specifications.

## What can technically be achieved with energy efficient fabric and services, and low carbon heat?

Focusing on the combinations that the planning system should incentivise, significant improvements over the existing Part L emissions can be achieved on-site with the SAP 10 carbon factors (>80%). This demonstrates that the 35% Part L improvement on-site (over existing regulated emission) is not adequate for major refurbishments of office buildings. Unless policy can be changed, the carbon offset price should correct this.

## Impact of PVs

PVs are not necessary to achieve the minimum 35% improvement on-site. Unless the carbon offset price is higher than the cost of installing PVs, their inclusion in the design will not be incentivised. This should be considered.

## Impact of carbon factor

If the analysis is done using an estimate for the future carbon factor for electricity (i.e. 71 gCO<sub>2</sub>/kWh) instead of SAP 10 (i.e. 233 gCO<sub>2</sub>/kWh), the conclusions above remain the same.

## Cost assessment

A cost assessment has not been undertaken for the office refurbishment 'typology' as refurbishment costs are very dependent on the scope of the refurbishment itself and specific to the building being refurbished and its condition.

Reduction in CO <sub>2</sub> - SAP 10.0 (reg)	With PV				
	Existing system	Gas boiler	VRF	Heat pump	Better heat pump
Business as usual	30%	53%	81%	74%	82%
Good practice	n/a	80%	87%	85%	87%
Ultra-low energy	n/a	89%	90%	90%	90%

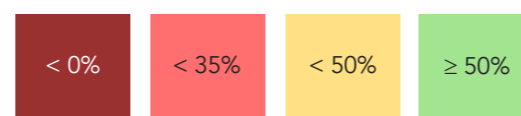

Must not be incentivised (gas heating) Should not be incentivised

Table 55 - Office (refurbishment) - Improvement over Part L assuming 233 gCO<sub>2</sub>/kWh (SAP 10.0) for grid-supplied electricity

Reduction in CO <sub>2</sub> - Future (reg)	With PV				
	Existing system	Gas boiler	VRF	Heat pump	Better heat pump
Business as usual	22%	49%	91%	88%	92%
Good practice	n/a	83%	94%	93%	94%
Ultra-low energy	n/a	93%	96%	95%	96%

PVs covering 50% of the roof

Reduction in CO <sub>2</sub> - SAP 10.0 (reg)	No PV				
	Existing system	Gas boiler	VRF	Heat pump	Better heat pump
Business as usual	25%	48%	76%	69%	78%
Good practice	n/a	73%	82%	80%	82%
Ultra-low energy	n/a	83%	85%	85%	85%

Table 56 - Office (refurbishment) - Impact of PVs

Reduction in CO <sub>2</sub> - SAP 10.0 (reg)	With PV				
	Existing system	Gas boiler	VRF	Heat pump	Better heat pump
Business as usual	30%	53%	81%	74%	82%
Good practice	n/a	80%	87%	85%	87%
Ultra-low energy	n/a	89%	90%	90%	90%

Electricity carbon factor set at 233 gCO<sub>2</sub>/kWh (SAP 10.0)

Reduction in CO <sub>2</sub> - Future (reg)	With PV				
	Existing system	Gas boiler	VRF	Heat pump	Better heat pump
Business as usual	22%	49%	91%	88%	92%
Good practice	n/a	83%	94%	93%	94%
Ultra-low energy	n/a	93%	96%	95%	96%

Electricity carbon factor set at 71 gCO<sub>2</sub>/kWh (Estimate 2020-2050)

Table 57 - Office (refurbishment) - Impact of changing the electricity carbon factor



# Is the carbon offset price sufficient to actually save carbon off-site?

## The AECOM London Carbon Offset price report

In 2017 the GLA commissioned AECOM to undertake the London Carbon Offset Price study. Key results are summarised in the adjacent table for a selection of measures. They indicate that the cost of carbon savings range from £25/tCO<sub>2</sub> to £800/tCO<sub>2</sub>. However, AECOM state in the report that "given the wide variability in the costs and carbon savings for potential carbon offsetting projects, it would be difficult to calculate robust costs per tonne of carbon."

We agree with that conclusion and consider that the most useful cost data in the tables are probably the whole house refurbishment data. These point to a carbon cost in the range of £185-£285/tCO<sub>2</sub>. As these costs actually date back from 2012, they would actually be approximately 20% higher if expressed in 2019 terms (i.e. **£222-£342**).

The true costs would also need to include administration and management of the programme. Initial anecdotal cost feedback from Energiesprong suggests a more significant cost.



Figure 53 - The London Carbon Offset Price report (© AECOM for the GLA)

## Data received from London Boroughs

The Smart Homes programme was delivered for private households across six London boroughs. At a total value of £7,875,000, it delivered carbon savings at a rate of approximately **£185/tCO<sub>2</sub>**.

A polybead insulation installation for 270 flats on a hard-to-treat medium-rise estate was delivered at approximately **£170/tCO<sub>2</sub>**.

RE-FIT works to three Council buildings in one of the boroughs delivered carbon savings at a rate of **£1,085/tCO<sub>2</sub>**.

## Feedback from London Boroughs

In his dissertation 'The Implementation of London's Zero Carbon Target and carbon pricing mechanisms', Jon Buick of UCL provides the following commentary on carbon prices, based on interviews with 8 London Boroughs.

"The view amongst boroughs interviewed is that the £60/tCO<sub>2</sub> price is neither an accurate reflection of the cost of onsite mitigation nor the cost of offsetting. [...]."

## RE-FIT and RE-NEW

The figure in the top right is an extract from a 2011 RE:NEW evaluation report.

## Conclusion

This evidence suggests that it would cost at least £300 t/CO<sub>2</sub> to a local authority to save carbon in a sustainable way. **Therefore, the current carbon offset price of £60-£95/tCO<sub>2</sub> is an underestimate and should be increased.**

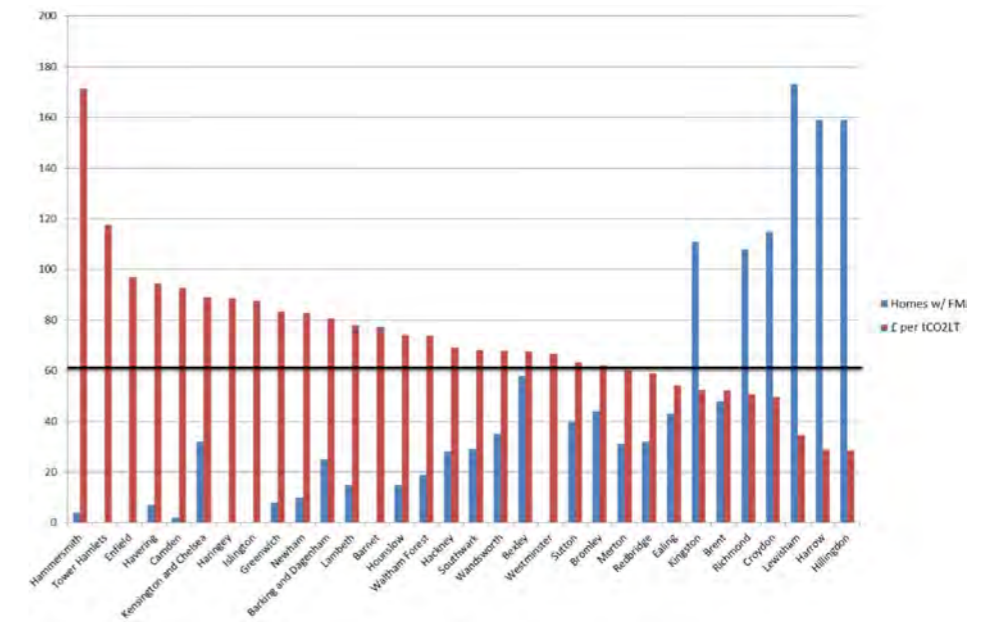

Figure 54 - Extract of the RE:NEW evaluation report

Measure	Annual		Lifetime	Lifetime carbon saving (t)	Cost of carbon saving (£/t)
	Installation cost (£)	carbon saving (kg)			
1 Cavity Wall Insulation (Low Cost)	£595	577	42	24.2	£25
2 Cavity Wall Insulation (High Cost)	£3,500	577	42	24.2	£144
3 Internal SWI	£5,300	1,187	36	42.7	£124
4 External SWI	£8,100	1,187	36	42.7	£190
5 Loft Insulation	£300	108	42	4.5	£66
6 Double Glazing (old single to A)	£4,500	492	20	9.8	£457
7 Flat roof insulation	£1,050	594	20	11.9	£88
8 Draughtproofing	£100	140	10	1.4	£71
9 New or replacement storage heaters	£350	562	20	11.2	£31
10 Solar water heating [-3.0 kW]	£4,615	289	20	5.8	£800
11 Photovoltaics [-2.0 kW]	£3,365	828	25	20.7	£163
12 Whole house refurb (SWI)	£14,400	1,672	30	50.7	£284
13 Whole house refurb (high cost CWI)	£9,800	1,215	30	36.8	£266
14 Whole house refurb (low cost CWI)	£6,895	1,215	30	36.8	£187
15 RE:NEW (average, easy measures)	£111	171	13	2.2	£51
16 RE:FIT Retrofit 11 non-domestic buildings	£730,000	595,000	19	11,210	£65
17 1km DHN to 850 homes & 2 leisure centres	£3,800,000	1,800,000	40	72,000	£53
18 1,000 LED streetlamps	£892,600	166,400	20	3,328	£268

Table 3: Costs and carbon savings for selected carbon saving measures.

Tables 58 and 59 - Tables extracted from the London Carbon Offset Price (© AECOM for the GLA)

Combustion measure	Annual		Lifetime	Lifetime carbon saving (t)	Cost of carbon saving (£/t)	Cost source
	Installation cost (£)	carbon saving (kg)				
<b>12 Whole house refurb (SWI)</b>	<b>£14,400</b>	<b>1672</b>	<b>30</b>	<b>50.7</b>	<b>£284.25</b>	<b>a</b>
External SWI	£8,100	1187	36	32.0	£189.60	a
Loft insulation	£300	108	42	3.4	£66.27	a
Floor insulation	£400	234	36	6.3	£47.45	a
Double Glazing (old single to A)	£4,500	492	20	7.4	£456.87	a
High performance replacement doors	£1,000	68	9	0.5	£1,622.72	a
Draughtproofing	£100	140	10	1.1	£71.33	a
<b>13 Whole house refurb (high cost CWI)</b>	<b>£9,800</b>	<b>1215</b>	<b>30</b>	<b>36.8</b>	<b>£266.27</b>	<b>a</b>
Cavity Wall Insulation (High Cost)	£3,500	577	42	18.2	£144.33	a
Loft insulation	£300	108	42	3.4	£66.27	a
Floor insulation	£400	234	36	6.3	£47.45	a
Double Glazing (old single to A)	£4,500	492	20	7.4	£456.87	a
High performance replacement doors	£1,000	68	9	0.5	£1,622.72	a
Draughtproofing	£100	140	10	1.1	£71.33	a
<b>14 Whole house refurb (low cost CWI)</b>	<b>£6,895</b>	<b>1215</b>	<b>30</b>	<b>36.8</b>	<b>£187.33</b>	<b>a</b>
Cavity Wall Insulation (Low Cost)	£595	577	42	18.2	£189.60	a
Loft insulation	£300	108	42	3.4	£66.27	a
Floor insulation	£400	234	36	6.3	£47.45	a
Double Glazing (old single to A)	£4,500	492	20	7.4	£456.87	a
High performance replacement doors	£1,000	68	9	0.5	£1,622.72	a
Draughtproofing	£100	140	10	1.1	£71.33	a

**Cost source**  
a DECC. (June 2012). Final Stage Impact Assessment for the Green Deal and Energy Company Obligation IA No. DECC0072. London: DECC. Table 49: Energy savings, Green Deal finance and ECO subsidy available for eligible measures, p. 138. [https://www.gov.uk/government/uploads/system/uploads/attachment\\_data/file/70265/5533-final-stage-impact-assessment-for-the-green-deal-a.pdf](https://www.gov.uk/government/uploads/system/uploads/attachment_data/file/70265/5533-final-stage-impact-assessment-for-the-green-deal-a.pdf)

## The issue with the current carbon price

The current carbon offset price (£60-£95/tCO<sub>2</sub>) and the London Plan requirement of a minimum 35% carbon reduction\* on-site do not incentivise sufficient savings on site. This means that new buildings have substantially higher on-site carbon emissions that they should if they were to achieve the net zero carbon policy requirement on-site.

**Significant improvements over Part L (using SAP 10.0 carbon factors) can be achieved now with efficient fabric, ventilation as well as low carbon heat.**

In addition, our analysis suggests that the current carbon offset price is not sufficient for local authorities to deliver the required carbon savings off-site. In order to address the mismatch between the current carbon offset price and the actual cost to deliver carbon offset projects offsite, a carbon price of at least £300/tCO<sub>2</sub> is recommended to enable them to deliver these carbon savings.

## A new carbon price: our recommendations

We have undertaken extensive energy modelling on several typologies of domestic and non-domestic buildings. Our calculations demonstrate that the significant reduction in the carbon factor for electricity used in the calculations means that, for the same specifications, a greater improvement over Part L is achieved with no extra effort. On this basis, and given the consensus on the need and benefit of a 'fabric first' approach and low carbon heat, our recommendations are:

- To incentivise on-site savings by adopting a **high first tier price of £1,000/tCO<sub>2</sub>** for those easily avoidable and unnecessary residual emissions not met on-site, which fall short of a 60% improvement threshold (measured over Part L1A) for domestic and a 50% improvement threshold (measured over Part L2A) for non-domestic developments.
- Once this level of performance is achieved we recommend the introduction of a **medium carbon price second tier of £300/tCO<sub>2</sub>** to continue to incentive PVs\*\*.
- Finally, and **only for residential applications** for which it is easier to achieve this high level of performance, we recommend a **low carbon price third tier of £100/tCO<sub>2</sub>** as a positive signal. A third tier is not appropriate for non-domestic buildings due to the limitations of the Part L2A modelling methodology.

\* The carbon reduction is calculated by comparing the proposed building carbon emissions to those of an equivalent 'notional' building using standard assumptions.

\*\* Our analysis suggests that with 233 gCO<sub>2</sub>/kWh (SAP 10.0) the savings from the use of PVs are equivalent to a carbon cost ratio of around £190/tCO<sub>2</sub>.

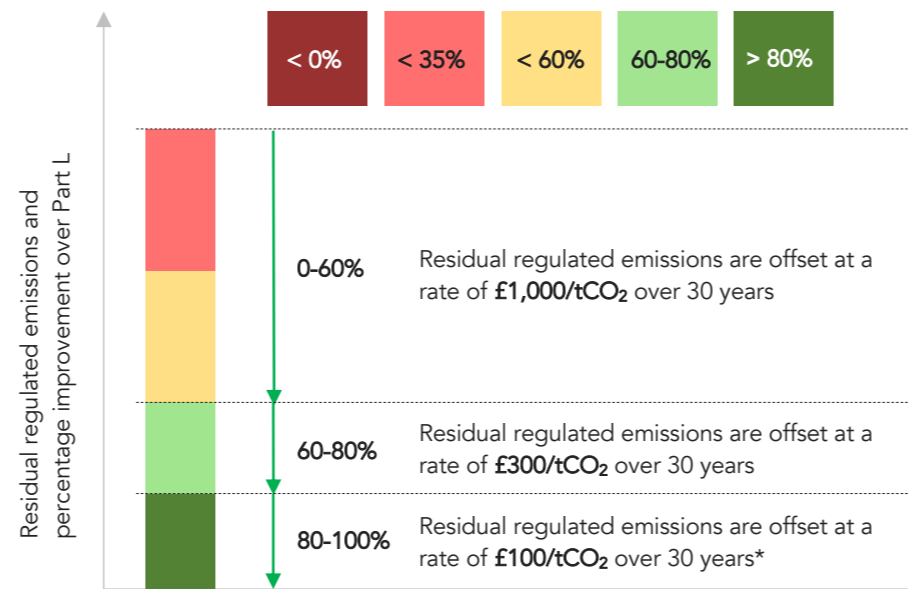

Figure 55 - Recommended tiered carbon prices for **domestic buildings**

The total carbon offset contribution will then be the sum of the above calculations (e.g. a residential application achieving a 58% improvement over Part L1A 2013 would offset 2% at £1,000/tCO<sub>2</sub> + 20% at £300/tCO<sub>2</sub> + £20% at £100/tCO<sub>2</sub>)

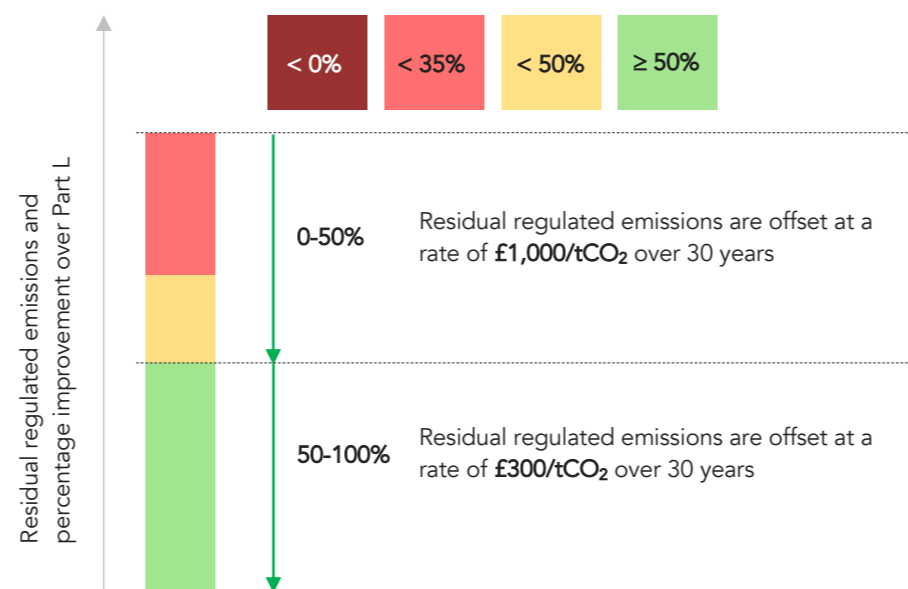

Figure 56 - Recommended tiered carbon prices for **non-domestic buildings**

The total carbon offset contribution will then be the sum of the above calculations (e.g. a non-domestic application achieving a 40% improvement over Part L1A 2013 would offset 10% at £1,000/tCO<sub>2</sub> + 50% at £300/tCO<sub>2</sub>)

## Example

Let us consider a mixed-use development including 10,000 sqm of residential space and 6,000 sqm of office space\*\*\*.

The **residential element** has a good practice level of building fabric and ventilation, a 'better' heat pump system and a PV area covering approximately 60% of the roof. It achieves a 75% improvement over Part L using SAP 10.0 carbon factors. This is equivalent to an area-weighted Dwelling Emission Rating (DER) of approximately 4.1 kgCO<sub>2</sub>/m<sup>2</sup>/year compared with the building regulation compliant baseline at 16.4 kgCO<sub>2</sub>/m<sup>2</sup>/year.

The **office element** has a 'business as usual' level of building fabric and ventilation, a heat pump and no PVs. It achieves a 47% improvement over Part L using SAP 10.0 carbon factors. This is equivalent to an area-weighted Building Emission Rating (BER) of approximately 11.8 kgCO<sub>2</sub>/m<sup>2</sup>/year compared with the building regulation compliant baseline at 22.3 kgCO<sub>2</sub>/m<sup>2</sup>/year.

## How to calculate the carbon offsetting contribution

The total **residential** carbon offsetting contribution would be: £73,800+£98,400 = **£172,200**

Residential	< 0%	0-35%	35-60%	60-80%	≥ 80%
Development (residential) tCO <sub>2</sub> /yr (assuming 10,000 sqm)	0	0	0	8.2	32.8
Carbon offsetting rate (residential)	£1000/t	£1000/t	£1000/t	£300/t	£100/t
<b>Carbon offsetting contribution (assuming 30 years) - residential</b>	<b>£0</b>	<b>£0</b>	<b>£0</b>	<b>£73,800</b>	<b>£98,400</b>

The total **office** carbon offsetting contribution would be: £117,000+£602,100 = **£719,100**

Office	< 0%	0-35%	35-50%	50-100%
Development (office) tCO <sub>2</sub> /yr (assuming 6,000 sqm)	0	0	3.9	66.9
Carbon offsetting rate (office)	£1000/t	£1000/t	£1000/t	£300/t
<b>Carbon offsetting contribution (assuming 30 years) - office</b>	<b>£0</b>	<b>£0</b>	<b>£117,000</b>	<b>£602,100</b>

Therefore, using the recommended tiered carbon prices, the total carbon offsetting contribution required from this large mixed-use application would be **£817,500**.

# Section 4

## Beyond Part L – we need to use predicted energy modelling to achieve Net Zero



- Accuracy of carbon savings estimate for domestic buildings
- Accuracy of carbon savings estimate for non-domestic buildings
- Is it a Net Zero Carbon building?
- Energy Use Intensity (EUI)

Energy Use Intensity (EUI)		No PV			
		Gas boiler	Direct electric	Heat pump	Better heat pump
Fabric & Ventilation	Business as usual	63	59	42	33
	Good practice	55	51	38	31
	Ultra-low energy	48	41	34	28



The terrace house and the mid-rise apartment building were modelled with both SAP and using a predicted energy use modelling tool (PHPP - Passivhaus Planning Package) and their results were compared. PHPP is recognised as an accurate tool at predicting energy use in low energy buildings. This page summarises our findings.

## The issue with the Part L1 method

**Percentage reduction.** The requirement for a minimum 35% on-site improvement over Part L1 for domestic buildings in London is driving higher on-site reductions than Building Regulations. However, this 'relative' approach is based on a comparison with a notional building. Aside from the confusion that it creates among project teams, the issue is that the notional building has the same form factor as the proposed design. The Part L1A method using percentage reduction does not reward efforts to improve the efficiency of the design itself.

**Differences between Fabric and Ventilation scenarios.** Part L1A (SAP) calculations were not intended to be used to predict the energy consumption breakdown of high performance buildings. In London, decisions on the implementation of energy efficiency measures, are often based on the Part L modelling. This is problematic, as the Part L model will not accurately show the effect of the fabric improvement on energy reductions. In general, Part L1A is likely to underestimate the effect of improving the fabric and ventilation specifications by approximately 30-40%.

## Proposed solution

This cannot be rectified by changing the carbon offset price, as this is a relatively blunt instrument which uses Part L. The Part L estimated energy consumption is not just out by a certain factor, both the proportion and magnitude of lighting, ventilation, heating and hot water are often not correct.

In Europe and the US, **predicted energy modelling** is routinely undertaken to understand how the building will perform in use. This is helpful, as design teams can predict the energy savings from better fabric and ventilation specifications, and understand if it is cost effective to implement energy saving measures.

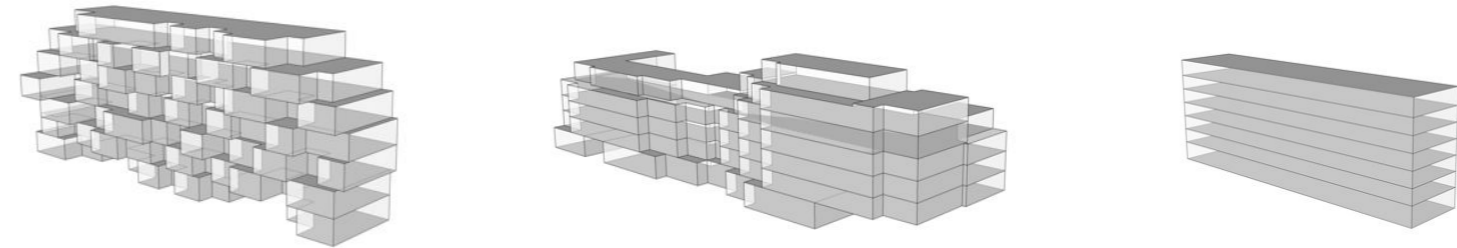

### Form factor

(ratio between external envelope area and internal floor areas)

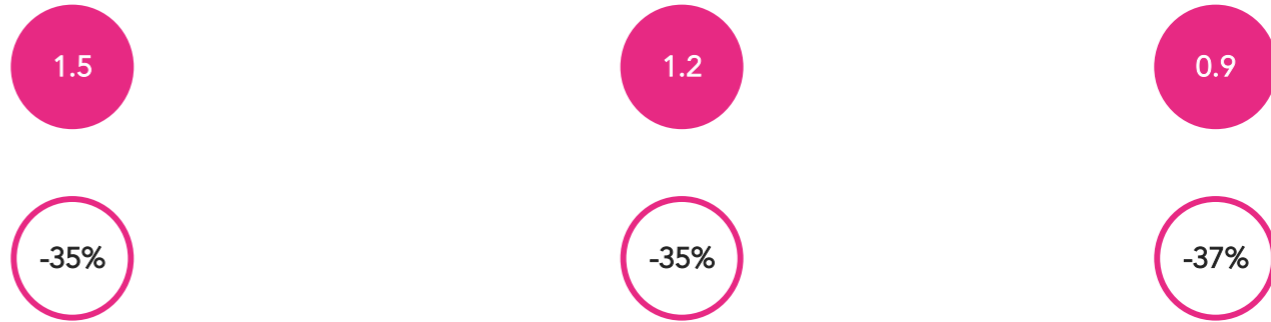

### Improvement over Part L 2013

(assuming good practice specifications)

Figure 57 - Despite the reduction in heat loss areas and complexity, the percentage improvement over Part L does not vary much between the designs above. This shows that a relative metric is not as useful and clear as an absolute metric for energy efficiency (e.g. kWh/m<sup>2</sup>/yr)

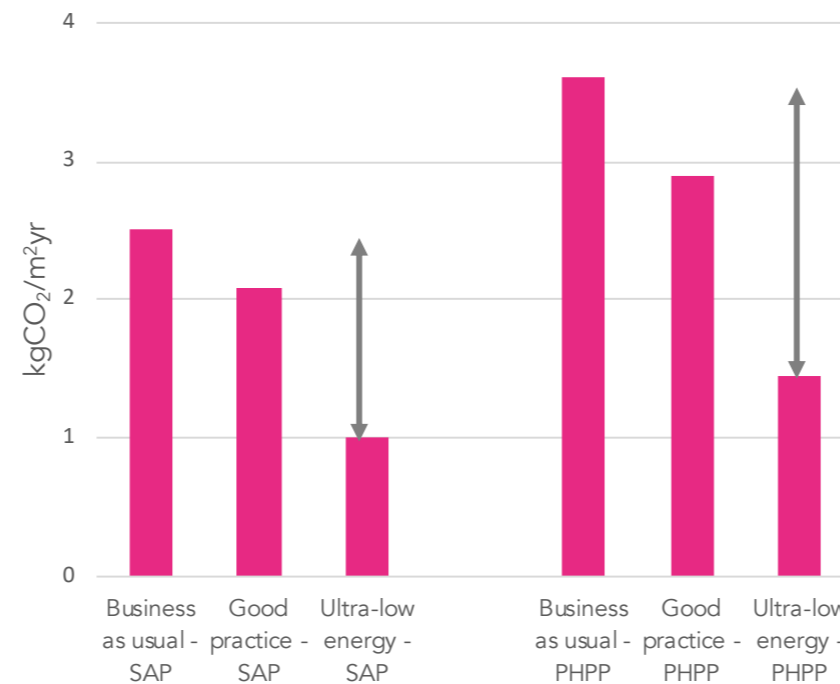

Figure 58 - Comparison of carbon emissions associated with space heating for the Terrace house: Part L1A (SAP) vs predicted energy use modelling (PHPP)

Capital cost uplift : **£72/m<sup>2</sup>**

### SAP

Carbon savings : **1.5 kgCO<sub>2</sub>/m<sup>2</sup>**

Cost per tonne CO<sub>2</sub> saved : **£1,600**

### PHPP

Carbon savings : **2.2 kgCO<sub>2</sub>/m<sup>2</sup>**

Cost per tonne CO<sub>2</sub> saved : **£1,100**

Terrace house - Cost per carbon tonne due to upgrading the fabric and ventilation from business as usual to ultra-low energy

The School was modelled both with a Part L2A/SBEM tool (TAS) and a predicted energy use modelling tool (PHPP-Passivhaus Planning Package) and their results were compared. PHPP is recognised as an accurate tool at predicting energy use in low energy buildings. This page summarises our findings.

## The issue with the Part L2 method

**Percentage reduction.** The difference in Part L improvement of changes to fabric and ventilation is very small, giving the impression that improving the specifications does not have a significant impact. This is a fundamental problem.

**Differences between Fabric and Ventilation scenarios.** Part L2A calculations were not intended to be used to predict the energy consumption breakdown of buildings, but they are. This is problematic, as the Part L2A energy calculations significantly underestimate the effect of improving the fabric and ventilation specifications.

## Proposed solution

This cannot be rectified by changing the carbon offset price. We would recommend using **predicted energy modelling to better estimate the impact of design and construction decisions.**



Figure 59 - Improvement in CO<sub>2</sub> emissions over Part L of the 3 fabric and ventilation cases for the three typologies (i.e. Hotel, School, Office)

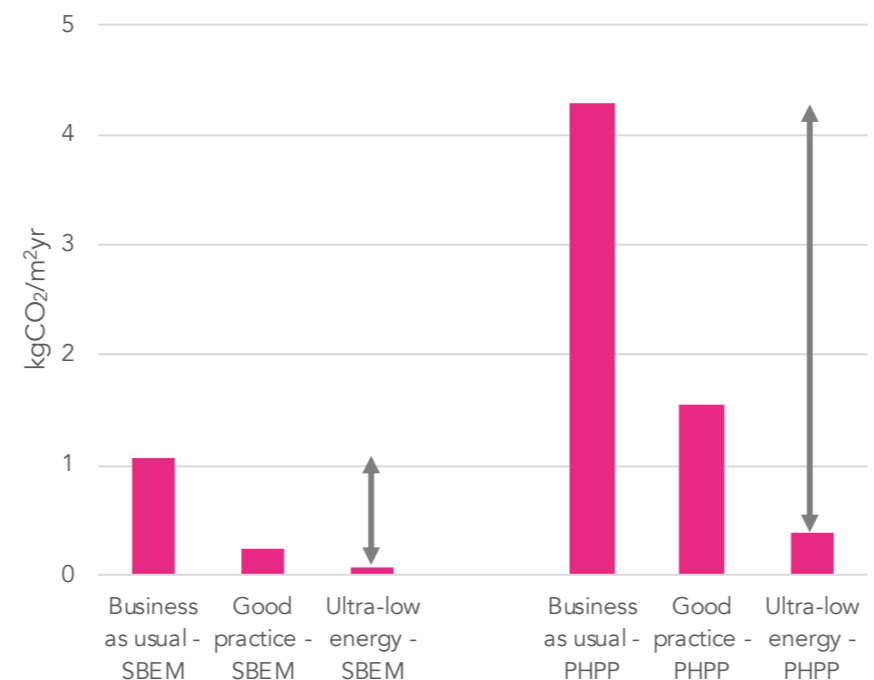

Figure 60 - Comparison of carbon emissions associated with space heating for the School: Part L2A (SBEM) vs predicted energy use modelling (PHPP)

The adjacent figure shows that

1. The spread of Part L performance between 'business as usual' and 'ultra-low energy' is very narrow. The difference in 'real life' performance is much wider.
2. The spread of Part L performance between 'business as usual' and 'ultra-low energy' is also much more narrow (i.e. 5-15%) than for domestic buildings.
3. As the Part L system is based on a relative approach and an underestimation of the space heating demand, it leads to results which do not follow the logical hierarchy (e.g. school).

**x4** reduction in heating carbon emissions due to ultra low energy fabric compared with Business as usual fabric

Capital cost uplift : **£75/m<sup>2</sup>**

### SAP

Carbon savings : **1 kgCO<sub>2</sub>/m<sup>2</sup>**

Cost per tonne CO<sub>2</sub> saved : **£2,500**

### PHPP

Carbon savings : **4 kgCO<sub>2</sub>/m<sup>2</sup>**

Cost per tonne CO<sub>2</sub> saved : **£600**

School - Cost per carbon tonne due to upgrading the fabric and ventilation from business as usual to ultra-low energy

## Does a 100% improvement over Part L carbon mean Net Zero Carbon?

Many of the boroughs have declared a climate emergency that involves borough wide zero emissions. It is crucial that the new buildings being approved in the next decade meet the requirements of achieving Zero Carbon for the Borough, so that these new buildings do not add to the building stock that requires retrofit.

The current Zero Carbon policy requires 35% carbon emission reductions on site, with the residual emissions offset. If implemented correctly the policy with the correct price of carbon could push to 100% regulated carbon emission reductions. Is that equivalent to Net Zero Carbon?

### Case study: Terrace house

The results of the modelling shows that the Terrace house achieves a 107% improvement over Part L with Ultra-low energy fabric and ventilation specifications, the standard heat pump system and 17m<sup>2</sup> of PV. Under current policy this would achieve the GLA zero carbon definition on-site and without offsets.

However this only includes regulated carbon emissions (emissions from heating, hot water, lighting, pumps and fans). Once unregulated energy is included, the house would still actually emit approximately 6 kgCO<sub>2</sub>/m<sup>2</sup>/yr. Moreover many studies show that there is a significant performance gap between SAP and in use energy and carbon emissions.

Therefore, a 100% improvement over Part L is not equivalent to Net Zero Carbon.

### Case study: School

For non residential buildings, SBEM massively underestimates energy consumption and in particular space heating even when including unregulated energy consumption. The results of the SBEM part L model are shown alongside results from PHPP and the new efficient schools benchmark for the good practice fabric and ventilation scenario with the standard heat pump system. Actual emissions are likely to be between 20 and 30 kgCO<sub>2</sub>/m<sup>2</sup>/yr, very far from Net Zero Carbon.

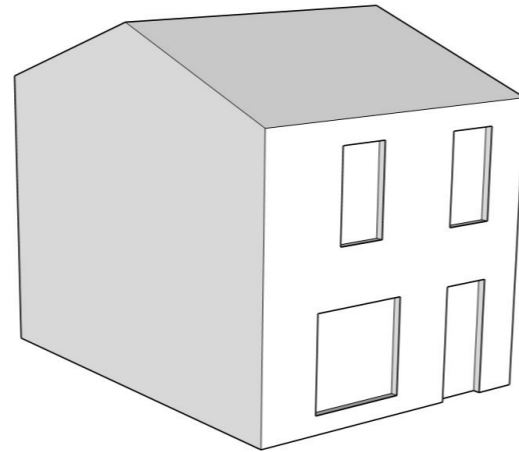

**107%** regulated carbon emission reduction over Part L

Ultra low energy fabric and vent  
Standard heat pump  
17m<sup>2</sup> of PV

Figure 61 - Terrace house modelled

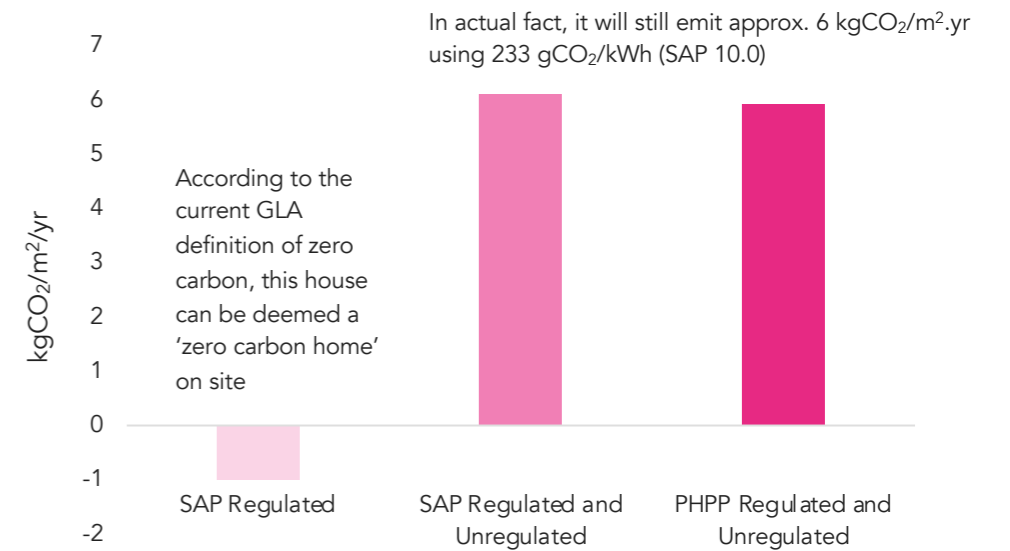
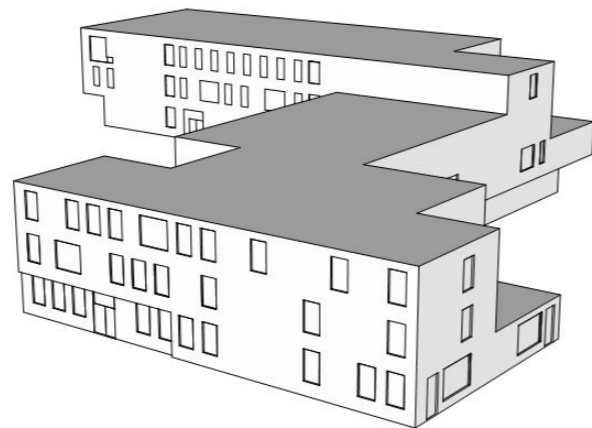
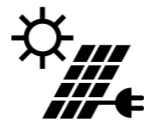

Figure 62 - Residual CO<sub>2</sub> emissions of the Terrace house with ultra low energy fabric and ventilation as well as a standard heat pump



**42%** regulated carbon emission reductions

Good practice fabric and vent  
Standard heat pump  
600m<sup>2</sup> of PV

Figure 63 - School modelled

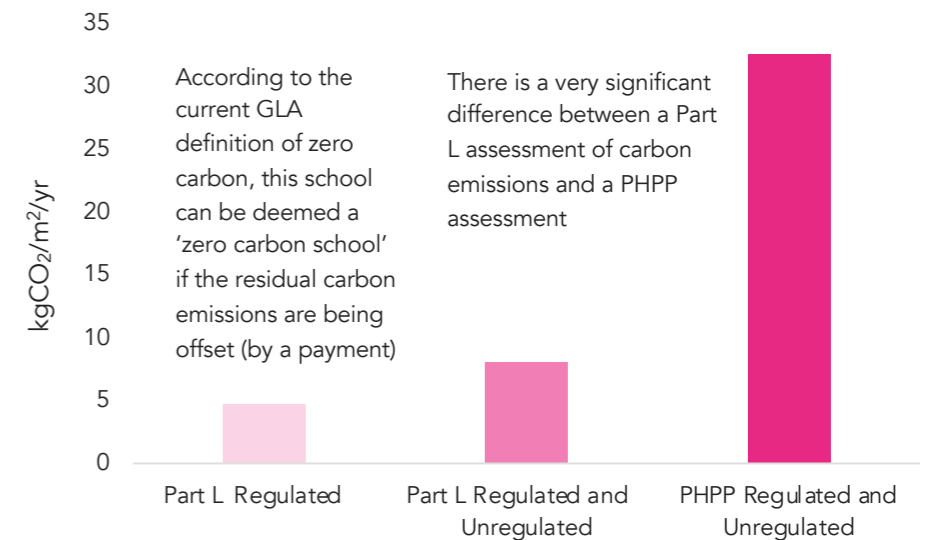

Figure 64 - Residual CO<sub>2</sub> emissions of School with good practice fabric and Standard heat pump



## The concept of Energy Use Intensity (EUI)

Energy modelling during the design of new buildings is normally restricted to Building Regulations Part L assessments of regulated energy uses, using the National Calculation Methodology (NCM). This approach is meant to be used only for demonstrating compliance with building regulations; rather than predicting energy use, it is based on standardised and simplified inputs and assumptions. The output is therefore not an 'actual' energy estimate, and is not meant to be one, but it is unfortunately used as one.

The predicted Energy Use Intensity (or EUI) represents the 'energy use at the meter'. It is the performance metric we would recommend as it facilitates year-on-year comparisons, and as it can easily be measured and understood by all stakeholders.

The adjacent tables illustrate the scale of EUI on three of the typologies from the PHPP modelling undertaken as part of this study.

### Other references on EUI

The RIBA 2030 Climate Challenge has been recently published and refers to operational energy metrics (see extracts below).

### EUI and heat networks

If a building is connected to a heat network, its EUI should not only take into the heat used and metered but also take account the generation and distribution losses.

### How to calculate the EUI?

There are softwares (e.g. PHPP) and methodologies (e.g. CIBSE TM54) which can be used to predict energy consumption and therefore EUIs.

It is possible that in the future standard tools (e.g. SAP, SBEM) could be used to predict energy use but they are not appropriate at the moment, particularly SBEM.

### Terrace House

Energy Use Intensity (EUI)		No PV			
		Gas boiler	Direct electric	Heat pump	Better heat pump
Fabric & Ventilation	Business as usual	98	89	48	42
	Good practice	86	78	43	38
	Ultra-low energy	64	58	35	31

Potential EUI requirement for Terrace houses	2020	2025
	60 kWh/m <sup>2</sup> /yr	35 kWh/m <sup>2</sup> /yr

Table 62 – Terrace House – Energy Use Intensities (EUI) of different combinations for the modelled house

### Mid-rise apartment building

Energy Use Intensity (EUI)		No PV			
		Gas boiler	Direct electric	Heat pump	Better heat pump
Fabric & Ventilation	Business as usual	63	59	42	33
	Good practice	55	51	38	31
	Ultra-low energy	48	41	34	28

Potential EUI requirement for Mid-rise apartment buildings	2020	2025
	60 kWh/m <sup>2</sup> /yr	35 kWh/m <sup>2</sup> /yr

Table 63 – Mid-rise apartment building – Energy Use Intensities (EUI) of different combinations for the modelled block

### School

Energy Use Intensity (EUI)		No PV			
		Gas boiler	Direct electric	Heat pump	Better heat pump
Fabric & Ventilation	Business as usual	114	109	86	76
	Good practice	87	83	76	72
	Ultra-low energy	71	68	67	66

Potential EUI requirement for Schools	2020	2025
	90 kWh/m <sup>2</sup> /yr	65 kWh/m <sup>2</sup> /yr

Table 64 – School – Energy Use Intensities (EUI) of different combinations for the modelled school

## RIBA 2030 Climate Challenge target metrics for domestic buildings

RIBA Sustainable Outcome Metrics	Current Benchmarks	2020 Targets	2025 Targets	2030 Targets	Notes
Operational Energy kWh/m <sup>2</sup> /y 	146 kWh/m <sup>2</sup> /y (Ofgem benchmark)	< 105 kWh/m <sup>2</sup> /y	< 70 kWh/m <sup>2</sup> /y	< 0 to 35 kWh/m <sup>2</sup> /y	UKGBC Net Zero Framework 1. Fabric First 2. Efficient services, and low-carbon heat 3. Maximise onsite renewables 4. Minimum offsetting using UK schemes (CCC)

## RIBA 2030 Climate Challenge target metrics for non-domestic buildings

RIBA Sustainable Outcome Metrics	Current Benchmarks	2020 Targets	2025 Targets	2030 Targets	Notes
Operational Energy kWh/m <sup>2</sup> /y 	225 kWh/m <sup>2</sup> /y DEC D rated (CIBSE TM46 benchmark)	< 170 kWh/m <sup>2</sup> /y DEC C rating	< 110 kWh/m <sup>2</sup> /y DEC B rating	< 0 to 55 kWh/m <sup>2</sup> /y DEC A rating	UKGBC Net Zero Framework 1. Fabric First 2. Efficient services, and low-carbon heat 3. Maximise onsite renewables 4. Minimum offsetting using UK schemes (CCC)

Tables 65 and 66 – Operational Energy Use Intensities (EUI) from the RIBA 2030 Climate Challenge

## Our recommendations for a better, simpler system

We recommend to introduce the following changes to the system now in order to set planning requirements on the right path towards Net Zero Carbon, and to step up the requirements over time.

- 1. Introduce Energy Use Intensity (EUI) requirements:** the use of maximum EUIs would help as it is an absolute metric, is independent from carbon and can be easily verified by the building/home owner/tenant after completion.
- 2. Request the prediction of energy use modelling:** We recommend to make the estimate of the building's future energy use mandatory. This could be done with PHPP (Passivhaus Planning Package) and/or other tools consistent with the CIBSE TM54 methodology.
- 3. Consider regulated and unregulated energy:** unregulated energy needs to be assessed in addition to regulated energy if Net Zero Carbon building is the destination.
- 4. Include planning conditions to address the performance gap:** more energy modelling and quality checks after planning, particularly during detailed design and construction would help to reduce the performance gap.

## Net Zero is possible

It is also important to realise that reaching Net Zero operational carbon on new residential buildings is technically possible assuming that an exemplar level of energy efficiency is achieved, that a low carbon heating system is used and that solar PVs are maximised on roofs.

## New KPIs for Net Zero

The adjacent table sets out a number of potential Key Performance Indicators (KPIs) for Net Zero Carbon. Our professional opinion is that they are very likely to form the basis of any future Net Zero Carbon standard. The KPIs highlight the importance of all elements below:

- Low energy use
- Embodied carbon
- Low carbon energy supply
- Measurement and verification
- Zero carbon balance

The adjacent column provides some indicative design requirements which are likely to comply with the KPIs. These are **not mandatory** to achieve the KPIs though.

	Key Performance Indicators (KPI)	Indicative design requirements to comply with KPIs
<b>Low energy use</b>	<b>Energy Use Intensity <sup>a</sup></b> < 35 kWh/m <sup>2</sup> /yr (GIA)  <b>Space heating demand <sup>b</sup></b> < 15 kWh/m <sup>2</sup> /yr (TFA) Hot water demand <sup>b</sup> <18 kWh/m <sup>2</sup> /yr (TFA) Other electricity consumption <sup>b</sup> <18 kWh/m <sup>2</sup> /yr (TFA)	1. Efficient form factor: < 0.8-1.2 2. Proportion of windows: 10-25% 3. External wall U-value < 0.13 W/m <sup>2</sup> .K 4. Floor U-value < 0.10 W/m <sup>2</sup> .K 5. Ground floor U-value < 0.10 W/m <sup>2</sup> .K 6. Thermal bridge free junctions 7. Triple-glazed windows 8. Airtightness < 1 m <sup>3</sup> /h/m <sup>2</sup> at 50 Pa 9. MVHR within 2m of external wall 10. WWHR (Waste Water Heat Recovery System) in each unit 11. Potential external shading to south and west facing windows to mitigate overheating
<b>Embodied carbon</b>	<b>Embodied carbon <sup>c</sup></b> < 500 kgCO <sub>2</sub> /m <sup>2</sup> /yr	11. To be detailed as part of project specific embodied carbon assessment
<b>Low carbon energy supply</b>	<b>No gas connection for heating/hot water or cooking</b> <b>Average annual carbon content of heat over 2020-2050 <sup>d</sup></b> < 70 gCO <sub>2</sub> /kWh  <b>PV area</b> > 50-70% of of the roof area  <b>Maximum peak demand</b> < 4kW/unit (average)	12. No gas boilers 13. Heating system analysis required  14. Target PV area > 100 kWh/m <sup>2</sup> (Building footprint)/yr  15. 100 litres of hot water storage per unit
<b>Measurement and verification</b>	<b>Predicted energy performance at each design stage and during construction</b>  <b>5-year energy monitoring post-construction</b>	16. Adequate sub-metering from key energy uses and renewables. 17. Post Occupancy Evaluation
<b>Zero operational carbon balance</b>	<b>Annual carbon balance for the whole development = 0 <sup>g</sup></b>	

<sup>a, b</sup> To be calculated using a predicted energy calculation methodology and software (e.g. PHPP). **Energy demand** represents the energy required and **energy consumption** represents the energy used by the system(s) to deliver this energy

<sup>c</sup> Embodied carbon target (Building Life Cycle Stages A1-A5). Includes Substructure, Superstructure, MEP, Facade & Internal Finishes.

<sup>d</sup> Bespoke calculation, including all losses and assuming an average carbon content of electricity over 2020-2050 of 70gCO<sub>2</sub>/kWh

Table 67 – Potential Key Performance Indicators for Net Zero Carbon residential buildings and associated (indicative) design requirement

# Appendices



- Impact of SAP 10.1 - Domestic example: impact on the mid-rise apartment building
- Impact of SAP 10.1 - Non-domestic example: impact on the school
- Energy and cost modelling assumptions



# Impact of SAP 10.1 | Mid-rise apartment building

## Mid-rise apartment building



### From SAP 10.0 to SAP 10.1

This page summarises the impact of a change in electricity carbon factor from 233 gCO<sub>2</sub>/kWh (SAP 10.0) to 136 gCO<sub>2</sub>/kWh (SAP 10.1).

### Impact on Part L improvement

This change would have a significant positive improvement on Part L improvements for electric solutions, with the higher impact for the scenarios with the highest heating demand. The change would mainly benefit the high carbon heat options electric options:

- The 'Direct electric' options would perform better by 13-23 percentage points;
- The 'Heat pump' options would perform better by 5-11 percentage points;
- The 'Better heat pump' options would perform better by 2-5 percentage points.

### Our recommendation for the tiered carbon price

This change would mainly affect the additional construction costs + carbon offsetting costs of the 'Direct electric' options, making them more attractive.

Reduction in CO <sub>2</sub> - SAP 10.0 (reg)		With PV			
		Gas boiler	Direct electric	Heat pump	Better heat pump
Fabric & Ventilation	Business as usual	<del>28%</del>	40%	71%	87%
	Good practice	<del>38%</del>	51%	77%	91%
	Ultra-low energy	<del>51%</del>	66%	86%	96%

Table 68 - Mid-rise apartment building - Improvement over Part L assuming 233 gCO<sub>2</sub>/kWh (SAP 10.0) for grid-supplied electricity



Reduction in CO <sub>2</sub> - SAP 10.1 (reg)		With PV			
		Gas boiler	Direct electric	Heat pump	Better heat pump
Fabric & Ventilation	Business as usual	<del>28%</del>	63%	82%	92%
	Good practice	<del>38%</del>	70%	86%	95%
	Ultra-low energy	<del>45%</del>	79%	91%	98%

Table 70 - Mid-rise apartment building - Improvement over Part L assuming 136 gCO<sub>2</sub>/kWh (SAP 10.1) for grid-supplied electricity

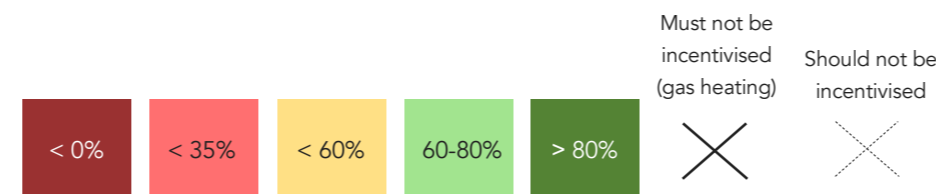

## Additional construction costs + carbon offsetting

£/m <sup>2</sup>		Gas boiler		Direct electric		Heat pump		Better heat pump	
Fabric & Ventilation	Business as usual	1A	196	1B	73	1C	59	1D	87
	Good practice	2A	186	2B	62	2C	89	2D	124
	Ultra-low energy	3A	150	3B	38	3C	110	3D	150

Table 69 - Mid-rise apartment building - Improvement over Part L assuming 233 gCO<sub>2</sub>/kWh (SAP 10.0) for grid-supplied electricity



£/m <sup>2</sup>		Gas boiler		Direct electric		Heat pump		Better heat pump	
Fabric & Ventilation	Business as usual	1A	209	1B	-28	1C	44	1D	85
	Good practice	2A	201	2B	2	2C	81	2D	122
	Ultra-low energy	3A	166	3B	18	3C	107	3D	150

Table 71 - Mid-rise apartment building - Improvement over Part L assuming 136 gCO<sub>2</sub>/kWh (SAP 10.1) for grid-supplied electricity

# Impact of SAP 10.1 | Office building (new)

Office building (new)

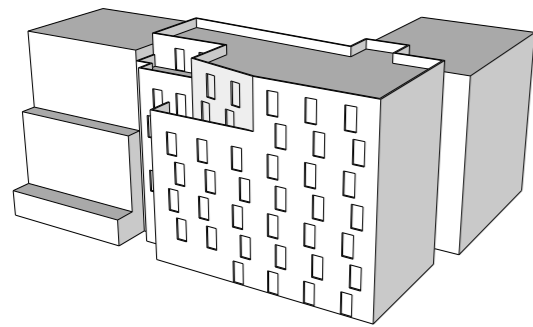

## From SAP 10.0 to SAP 10.1

This page summarises the impact of a change in electricity carbon factor from 233 gCO<sub>2</sub>/kWh (SAP 10.0) to 136 gCO<sub>2</sub>/kWh (SAP 10.1).

## Impact on Part L improvement

This change would have a positive improvement on Part L improvements for electric solutions. The impact would be fairly similar between the fabric and ventilation options and the heating systems:

- The 'VRF' options would perform better by 5-8 percentage points;
- The 'Heat pump' options would perform better by 6-8 percentage points;
- The 'Better heat pump' options would perform better by 5-7 percentage points.

## Our recommendation for the tiered carbon price

This change would generally reduce the additional construction costs + carbon offsetting costs of all options.

		Reduction in CO <sub>2</sub> - SAP 10.0 (reg)	With PV			
			Gas boiler	VRF	Heat pump	Better heat pump
Fabric & Ventilation	Business as usual	<del>29%</del>	48%	44%	49%	
	Good practice	<del>4%</del>	54%	51%	55%	
	Ultra-low energy	<del>55%</del>	61%	59%	61%	

Table 72 - Office building (new) - Improvement over Part L assuming 233 gCO<sub>2</sub>/kWh (SAP 10.0) for grid-supplied electricity



		Reduction in CO <sub>2</sub> - SAP 10.1 (reg)	With PV			
			Gas boiler	VRF	Heat pump	Better heat pump
Fabric & Ventilation	Business as usual	<del>22%</del>	56%	52%	56%	
	Good practice	<del>38%</del>	60%	58%	61%	
	Ultra-low energy	<del>55%</del>	66%	65%	66%	

Table 74 - Office building (new) - Improvement over Part L assuming 136 gCO<sub>2</sub>/kWh (SAP 10.1) for grid-supplied electricity

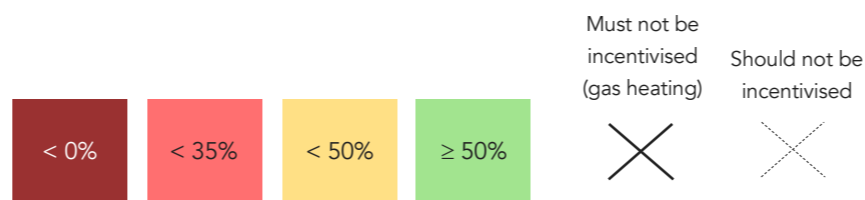

## Additional construction costs + carbon offsetting

		£/m <sup>2</sup>		Gas boiler		Direct electric		Heat pump		Better heat pump	
Fabric & Ventilation	Business as usual	1A	100	1B	-26	1C	82	1D	183		
	Good practice	2A	170	2B	83	2C	157	2D	238		
	Ultra-low energy	3A	188	3B	138	3C	192	3D	252		

Table 73 - Office building (new) - Improvement over Part L assuming 233 gCO<sub>2</sub>/kWh (SAP 10.0) for grid-supplied electricity



		£/m <sup>2</sup>		Gas boiler		Direct electric		Heat pump		Better heat pump	
Fabric & Ventilation	Business as usual	1A	49	1B	-47	1C	50	1D	163		
	Good practice	2A	138	2B	67	2C	140	2D	222		
	Ultra-low energy	3A	175	3B	124	3C	177	3D	238		

Table 75 - Office building (new) - Improvement over Part L assuming 136 gCO<sub>2</sub>/kWh (SAP 10.1) for grid-supplied electricity

# Energy and cost modelling assumptions | Terrace house

## Methodology

We carried out Part L modelling using accredited softwares and we post-processed the results using different carbon factors.

This page summarises the key assumptions used for the energy models.

## Typology

A row of 8 terrace houses has been considered as a case study. The mid-terrace floor area is 95 sqm GIA.

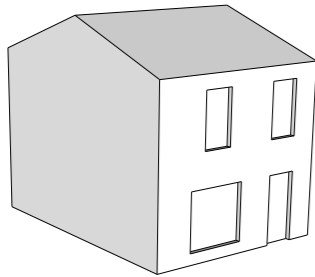

## Fabric and Ventilation

See adjacent table.

## Heating system

See adjacent table.

## PVs

We have assumed a PV area of 17m<sup>2</sup> on the house.

## Key cost assumptions

- Indicative total construction cost £1,800/m<sup>2</sup>
- Masonry construction with good quality wool based insulation in walls and roof space
- Heating in A is an 18kW system boiler
- Heating C is 8.5kW ASHP
- Heating D is 5kW ASHP with integrated cylinder
- WWHR is a vertical pipe based system

Fabric and ventilation specifications for the **Terrace house**

	1. Business as usual ★	2. Good practice ★★	3. Ultra-low energy ★★★
Average floor U-value	0.11 W/m <sup>2</sup> K	0.10 W/m <sup>2</sup> K	0.08 W/m <sup>2</sup> K
Average wall U-value	0.18 W/m <sup>2</sup> K	0.15 W/m <sup>2</sup> K	0.12 W/m <sup>2</sup> K
Average roof U-value	0.13 W/m <sup>2</sup> K	0.12 W/m <sup>2</sup> K	0.10 W/m <sup>2</sup> K
Average window U-value	1.40 W/m <sup>2</sup> K	1.20 W/m <sup>2</sup> K	0.80 W/m <sup>2</sup> K
Thermal bridge performance	Good practice (e.g. y-value ≈ 0.08 W/m <sup>2</sup> K)	Better practice (e.g. y-value ≈ 0.06 W/m <sup>2</sup> K)	Best practice (e.g. y-value ≈ 0.04 W/m <sup>2</sup> K)
Ventilation	Good quality MVHR Long ducts to outside	Good quality MVHR Long ducts to outside	High quality MVHR Short ducts to outside
Ventilation system heat recovery efficiency	85%	85%	90%
Ventilation system SFP	0.8 W/l/s (SAP) 1.75 W/l/s (PHPP)	0.7 W/l/s (SAP) 1.25 W/l/s (PHPP)	0.6 W/l/s (SAP) 0.85 W/l/s (PHPP)
Airtightness	<3m <sup>3</sup> /m <sup>2</sup> h	<3m <sup>3</sup> /m <sup>2</sup> h	<1m <sup>3</sup> /m <sup>2</sup> h

Heating systems considered for the **Terrace house**

	A. Gas boiler	B. Direct electric	C. Heat pump	D. Better heat pump
Heating Source	Individual gas boiler	Direct electric panel radiators providing heating	Individual heat pump serving residential unit	Individual heat pump serving residential unit
Heating system	LTHW radiators fed by gas boiler	Direct electric panel radiators	LTHW radiators fed by heat pump	LTHW radiators fed by heat pump
Hot water system	180L hot water store in residential unit	80L hot water store with an immersion heater	180L hot water store	180L hot water store WWHR for the showers
Heating and hot water seasonal efficiency	89.5%	100%	270% space heating 210% water heating Blended efficiencies for SAP models 1/2/3: 253% /245%/235%	330% space heating 280% water heating Blended efficiencies for SAP models 1/2/3: 317%/311%/303%



# Energy and cost modelling assumptions | Mid-rise apartment building

## Methodology

We carried out Part L modelling using accredited softwares and we post-processed the results using different carbon factors.

This page summarises the key assumptions used for the energy models.

## Typology

A 5-storey apartment building has been considered as a case study. Its floor area is 3,200 sqm GIA.

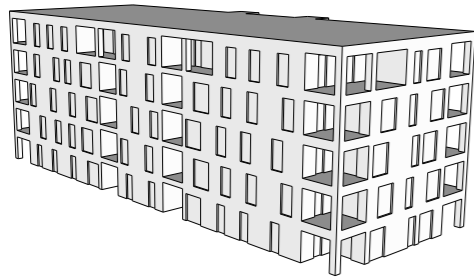

## Fabric and Ventilation

See adjacent table.

## Heating system

See adjacent table.

## PVs

We have assumed a PV area of 250m<sup>2</sup> on the mid-rise apartment building.

## Key cost assumptions

- Indicative total construction cost £2,200/m<sup>2</sup>
- Light metal frame external walls with good quality wool insulation
- Heating in A is an shared gas boiler with 4kW per home and a HIU in unit for heating and hot water
- Heating C is shared ASHP with 4kW per home and a HIU in unit for heating and hot water
- Heating D is 4kW local WSHP connected to a shared ambient loop with ground array
- WWHR is a vertical pipe based system for floors 1 and above and a horizontal tray system on the ground floor

Fabric and ventilation specifications for the **Mid-rise apartment building**

	1. Business as usual ★	2. Good practice ★★	3. Ultra-low energy ★★★
Average floor U-value	0.13 W/m <sup>2</sup> K	0.10 W/m <sup>2</sup> K	0.08 W/m <sup>2</sup> K
Average wall U-value	0.18 W/m <sup>2</sup> K	0.15 W/m <sup>2</sup> K	0.13 W/m <sup>2</sup> K
Average roof U-value	0.15 W/m <sup>2</sup> K	0.12 W/m <sup>2</sup> K	0.10 W/m <sup>2</sup> K
Average window U-value	1.40 W/m <sup>2</sup> K	1.20 W/m <sup>2</sup> K	0.80 W/m <sup>2</sup> K
Thermal bridge performance	Good practice (e.g. y-value ≈ 0.1 W/m <sup>2</sup> K)	Better practice (e.g. y-value ≈ 0.07 W/m <sup>2</sup> K)	Best practice (e.g. y-value ≈ 0.04 W/m <sup>2</sup> K)
Ventilation	Good quality MVHR Long ducts to outside	High quality MVHR long ducts to outside	High quality MVHR short ducts to outside
Ventilation system heat recovery efficiency	85%	90%	90%
Ventilation system SFP	0.8 W/l/s (SAP) 1.75 W/l/s (PHPP)	0.7 W/l/s (SAP) 1.25 W/l/s (PHPP)	0.6 W/l/s (SAP) 0.85 W/l/s (PHPP)
Airtightness	<3m <sup>3</sup> /m <sup>2</sup> h	<3m <sup>3</sup> /m <sup>2</sup> h	<1m <sup>3</sup> /m <sup>2</sup> h

Heating systems considered for the **Mid-rise apartment building**

	A. Gas boiler	B. Direct electric	C. Heat pump	D. Better heat pump
Heating Source	Communal gas boiler serving a communal heating system with flow and return temperature 70°C /50°C	Direct electric panel radiators providing heating	Air source heat pumps serving a communal heating system with flow and return temperature 65°C /50°C and communal thermal stores	An ambient loop fed by communal ground loops or sources of secondary heat Small individual heat pumps (water-source) in each residential unit
Heating system	LTHW radiators fed by HIU	Direct electric panel radiators	LTHW radiators fed by HIU	LTHW radiators fed by individual heat pump
Hot water system	HIU provides instantaneous hot water	An 80L hot water store with an immersion heater in each residential unit	HIU provides instantaneous hot water	An 80L hot water store. Waste water heat recovery for the showers in each residential unit
Heating and hot water seasonal efficiency	93%	100%	190% space heating 210% water heating Blended efficiencies for SAP models 1/2/3: 200% /201% / 204%	330% space heating 280% water heating Blended efficiencies for SAP models 1/2/3: 304% / 300% /293%

# Energy and cost modelling assumptions | High-rise apartment building

## Methodology

We carried out Part L modelling using accredited softwares and we post-processed the results using different carbon factors.

This page summarises the key assumptions used for the energy models.

## Typology

A 25-storey apartment building has been considered as a case study. Its floor area is 14,600 sqm GIA.

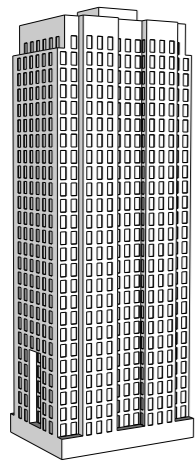

## Fabric and Ventilation

See adjacent table.

## Heating system

See adjacent table.

## PVs

We have assumed a PV area of 150m<sup>2</sup> on the high-rise apartment building.

## Key cost assumptions

- Indicative total construction cost £3,100/m<sup>2</sup>
- Light metal frame external walls with good quality wool insulation
- Heating in A is an shared gas boiler with 4kW per home and a HIU in unit for heating and hot water
- Heating C is shared ASHP with 4kW per home and a HIU in unit for heating and hot water
- Heating D is 4kW local WSHP connected to a shared ambient loop with ground array
- WWHR is a vertical pipe based system for floors 1 and above and a horizontal tray system on the ground floor

Fabric and ventilation specifications for the High-rise apartment building

	1. Business as usual ★	2. Good practice ★★	3. Ultra-low energy ★★★
Average floor U-value	0.13 W/m <sup>2</sup> K	0.10 W/m <sup>2</sup> K	0.08 W/m <sup>2</sup> K
Average wall U-value	0.18 W/m <sup>2</sup> K	0.15 W/m <sup>2</sup> K	0.13 W/m <sup>2</sup> K
Average roof U-value	0.15 W/m <sup>2</sup> K	0.12 W/m <sup>2</sup> K	0.10 W/m <sup>2</sup> K
Average window U-value	1.40 W/m <sup>2</sup> K	1.20 W/m <sup>2</sup> K	0.90 W/m <sup>2</sup> K
Thermal bridge performance	Good practice (e.g. y-value ≈ 0.15 W/m <sup>2</sup> K)	Better practice (e.g. y-value ≈ 0.10 W/m <sup>2</sup> K)	Best practice (e.g. y-value ≈ 0.06 W/m <sup>2</sup> K)
Ventilation	Good quality MVHR Long ducts to outside	High quality MVHR Long ducts to outside	High quality MVHR Short ducts to outside
Ventilation system heat recovery efficiency	85%	90%	90%
Ventilation system SFP	0.8 W/l/s (SAP)	0.7 W/l/s (SAP)	0.6 W/l/s (SAP)
Airtightness	<3m <sup>3</sup> /m <sup>2</sup> h	<3m <sup>3</sup> /m <sup>2</sup> h	<1m <sup>3</sup> /m <sup>2</sup> h

Heating systems considered for the High-rise apartment building

	A. Gas boiler	B. Direct electric	C. Heat pump	D. Better heat pump
Heating Source	Communal gas boiler serving a communal heating system with flow and return temperature 70°C/50°C	Direct electric panel radiators providing heating	Air source heat pumps serving a communal heating system with flow and return temperature 65°C/50°C and communal thermal stores	An ambient loop fed by communal ground loops or sources of secondary heat Small individual heat pumps (water-source) in each residential unit
Heating system	LTHW radiators fed by HIU	Direct electric panel radiators	LTHW radiators fed by HIU	LTHW radiators fed by individual heat pump
Hot water system	HIU provides instantaneous hot water	An 80L hot water store with an immersion heater in each residential unit	HIU provides instantaneous hot water	An 80L hot water store. Waste water heat recovery for the showers in each residential unit
Heating and hot water seasonal efficiency	93%	100%	190% space heating 210% water heating Blended efficiencies for SAP models 1/2/3: 200% /201%/204%	330% space heating 280% water heating Blended efficiencies for SAP models 1/2/3: 304%/300%/293%

# Energy and cost modelling assumptions | Hotel

## Methodology

We carried out Part L modelling using accredited softwares and we post-processed the results using different carbon factors.

This page summarises the key assumptions used for the energy models.

## Typology

A 9-storey hotel has been considered as a case study. Its floor area is 3,600 sqm GIA.

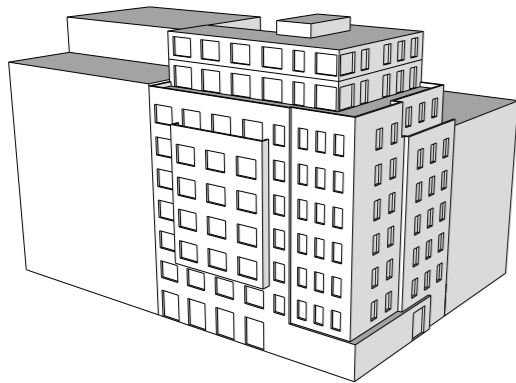

## Fabric and Ventilation

See adjacent table.

## Heating system

See adjacent table.

## PVs

We have assumed a PV area of 120m<sup>2</sup> on the hotel.

## Key cost assumptions

- Indicative total construction cost £3,000/m<sup>2</sup>
- Light metal frame external walls with good quality wool insulation
- Heating in A is an gas boiler of 635-180kW depending on fabric specification
- Heating C and D are ASHP or GSHP respectively. Sizes range from 520-65kW depending on fabric specification

Fabric and ventilation specifications for the **Hotel**

	1. Business as usual ★	2. Good practice ★★	3. Ultra-low energy ★★★
Average floor U-value	0.15 W/m <sup>2</sup> K	0.12 W/m <sup>2</sup> K	0.09 W/m <sup>2</sup> K
Average wall U-value	0.25 W/m <sup>2</sup> K	0.18 W/m <sup>2</sup> K	0.13 W/m <sup>2</sup> K
Average roof U-value	0.15 W/m <sup>2</sup> K	0.13 W/m <sup>2</sup> K	0.10 W/m <sup>2</sup> K
Average window U-value	1.40 W/m <sup>2</sup> K	1.20 W/m <sup>2</sup> K	0.80 W/m <sup>2</sup> K
Thermal bridge performance	Ignored (5% of losses)	Good practice (3% of losses)	Best practice (1% of losses)
Ventilation	Standard quality AHU	Good quality AHU	Best practice AHU
Ventilation system heat recovery efficiency	75%	80%	90%
Ventilation system SFP	1.6 W/l/s	1.4 W/l/s	1.2 W/l/s
Airtightness	<5m <sup>3</sup> /m <sup>2</sup> h	<3m <sup>3</sup> /m <sup>2</sup> h	<1m <sup>3</sup> /m <sup>2</sup> h

Heating systems considered for the **Hotel**

	A. Gas boiler	B. Direct electric	C. Heat pump	D. Better heat pump
Heating Source	Gas boiler serving a heating system with flow and return temperature 70°C /50°C	VRF units	Heat pumps serving a heating system with flow and return temperature 65°C /50°C	Heat pumps serving a heating system with low flow and return temperature 45°C /40°C fed ground source array
Heating system	LTHW Fan Coil Unit fed by gas boiler	Fan Coil Unit fed by VRF	LTHW Fan Coil Unit fed by Reversible chiller/heat pump	LTHW Fan Coil Unit fed by Reversible chiller/heat pump
Hot water system	A 2,000L hot water store	A 2,000L hot water store fed by VRF heat pump	A 2,000L hot water store	A 2,000L hot water store
Heating and hot water seasonal efficiency	95%	400% for heating 300% for hot water	220%	450% for heating 300% for hot water (top up 2nd stage heat pump)



# Energy and cost modelling assumptions | School

## Methodology

We carried out Part L modelling using accredited softwares and we post-processed the results using different carbon factors.

This page summarises the key assumptions used for the energy models.

## Typology

A 3/4 storey school has been considered as a case study. Its floor area is 6,000 sqm GIA.

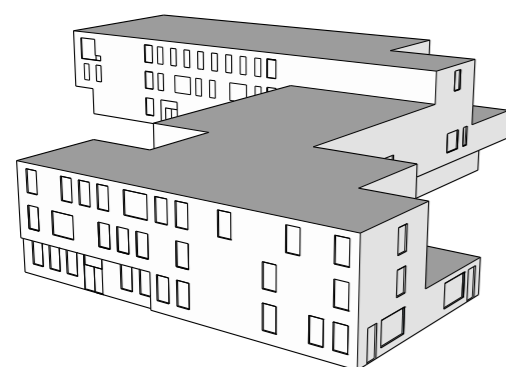

## Fabric and Ventilation

See adjacent table.

## Heating system

See adjacent table.

## PVs

We have assumed a PV area of 600m<sup>2</sup> on the school.

## Key cost assumptions

- Indicative total construction cost £3,800/m<sup>2</sup>
- Light metal frame external walls with good quality wool insulation
- Heating in A is an gas boiler of 518-266kW depending on fabric specification
- Heating C and D are ASHP or GSHP respectively. Sizes range from 540-252kW depending on fabric specification. The GSHP option is supported by an additional 105kW ASHP to provide additional hot water supply

## Fabric and ventilation specifications for the School

	1. Business as usual ★	2. Good practice ★★	3. Ultra-low energy ★★★
Average floor U-value	0.15 W/m <sup>2</sup> K	0.12 W/m <sup>2</sup> K	0.09 W/m <sup>2</sup> K
Average wall U-value	0.20 W/m <sup>2</sup> K	0.18 W/m <sup>2</sup> K	0.13 W/m <sup>2</sup> K
Average roof U-value	0.15 W/m <sup>2</sup> K	0.13 W/m <sup>2</sup> K	0.11 W/m <sup>2</sup> K
Average window U-value	1.40 W/m <sup>2</sup> K	1.20 W/m <sup>2</sup> K	0.80 W/m <sup>2</sup> K
Thermal bridge performance	Ignored (5% of losses)	Good practice (3% of losses)	Best practice (1% of losses)
Ventilation	Fan assisted ventilation	Good quality MVHR	Best practice MVHR
Ventilation system heat recovery efficiency	0%	70%	90%
Ventilation system SFP	0.5 W/l/s	1.6 W/l/s	1.2 W/l/s
Airtightness	<5m <sup>3</sup> /m <sup>2</sup> h	<3m <sup>3</sup> /m <sup>2</sup> h	<1m <sup>3</sup> /m <sup>2</sup> h

## Heating systems considered for the School

	A. Gas boiler	B. Direct electric	C. Heat pump	D. Better heat pump
Heating Source	Gas boiler serving a heating system with flow and return temperature 70°C /50°C	Direct electric panel radiators providing heating	Air source heat pumps serving a heating system with flow and return temperature 65°C /50°C	Ground source heat pumps serving a heating system with low flow and return temperature 45°C /40°C fed from a ground source array
Heating system	LTHW radiators fed by gas boiler	Direct electric panel radiators	LTHW radiators fed by heat pump	LTHW radiators fed by heat pump
Hot water system	A 1,000L hot water store	Direct electric point-of-use hot water to bathrooms	Direct electric point-of-use hot water to bathrooms	Direct electric point-of-use hot water to bathrooms
Heating and hot water seasonal efficiency	93%	100%	190% space heating 100% water heating	330% space heating 100% water heating

# Energy and cost modelling assumptions | Office (new build)

## Methodology

We carried out Part L modelling using accredited softwares and we post-processed the results using different carbon factors.

This page summarises the key assumptions used for the energy models.

## Typology

A 7-storey office has been considered as a case study. Its floor area is 4,000 sqm GIA.

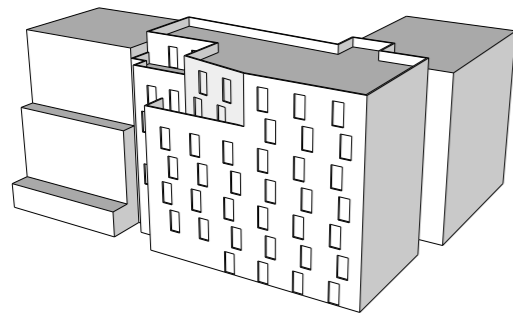

## Fabric and Ventilation

See adjacent table.

## Heating system

See adjacent table.

## PVs

We have assumed a PV area of 215m<sup>2</sup> on the office.

## Key cost assumptions

- Indicative total construction cost £3,600/m<sup>2</sup>
- Light metal frame external walls with good quality wool insulation
- Heating in A is an gas boiler of 246-86kW depending on fabric specification
- Heating C and D are ASHP or GSHP respectively. Sizes range from 348-160W depending on fabric specification. The GSHP option is supported by an additional 21kW ASHP to provide additional hot water supply for shower facilities (instantaneous electric hot water elsewhere).

Fabric and ventilation specifications for the **Office (new build)**

	1. Business as usual ★	2. Good practice ★★	3. Ultra-low energy ★★★
Average floor U-value	0.15 W/m <sup>2</sup> K	0.12 W/m <sup>2</sup> K	0.09 W/m <sup>2</sup> K
Average wall U-value	0.25 W/m <sup>2</sup> K	0.18 W/m <sup>2</sup> K	0.13 W/m <sup>2</sup> K
Average roof U-value	0.15 W/m <sup>2</sup> K	0.13 W/m <sup>2</sup> K	0.10 W/m <sup>2</sup> K
Average window U-value	1.60 W/m <sup>2</sup> K	1.40 W/m <sup>2</sup> K	0.80 W/m <sup>2</sup> K
Thermal bridge performance	Ignored (5% of losses)	Good practice (3% of losses)	Best practice (1% of losses)
Ventilation	Standard quality AHU	Good quality AHU	Best practice AHU
Ventilation system heat recovery efficiency	75%	80%	90%
Ventilation system SFP	1.8 W/l/s	1.6 W/l/s	1.2 W/l/s
Airtightness	<5m <sup>3</sup> /m <sup>2</sup> h	<3m <sup>3</sup> /m <sup>2</sup> h	<1m <sup>3</sup> /m <sup>2</sup> h

Heating systems considered for the **Office (new build)**

	A. Gas boiler	B. VRF	C. Heat pump	D. Better heat pump
Heating Source	Gas boiler serving a heating system with flow and return temperature 70°C /50°C	VRF	Heat pumps serving a heating system with flow and return temperature 65°C /50°C	Heat pumps serving a heating system with low flow and return temperature 45°C /40°C fed from ambient loop or ground source array
Heating system	LTHW Fan Coil Unit fed by gas boiler	Fan Coil Unit fed by VRF	LTHW Fan Coil Unit fed by Reversible chiller/heat pump	LTHW Fan Coil Unit fed by Reversible chiller/heat pump
Hot water system	Direct electric hot water to toilets A 400L hot water store for the showers fed by gas boiler	Direct electric hot water to toilets And electric showers	Direct electric hot water to toilets A 400L hot water store for the showers fed by the heat pump	Direct electric hot water to toilets A 400L hot water store for the showers fed by the heat pump
Heating and hot water seasonal efficiency	95%	350% for heating 100% for hot water	220%	450% for heating 300% for hot water (top up 2nd stage heat pump)

# Energy and cost modelling assumptions | Office (refurbishment)

## Methodology

We carried out Part L modelling using accredited softwares and we post-processed the results using different carbon factors.

This page summarises the key assumptions used for the energy models.

## Typology

A 7-storey office has been considered as a case study. Its floor area is 4,000 sqm GIA.

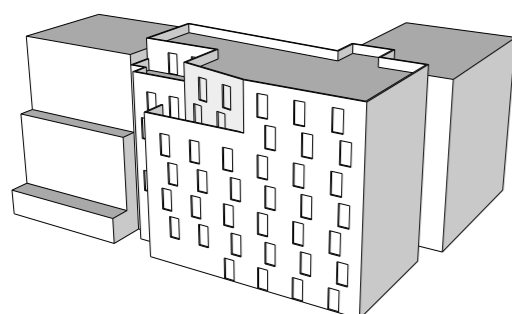

## Fabric and Ventilation

See adjacent table.

## Heating system

See adjacent table.

## PVs

We have assumed a PV area of 215m<sup>2</sup> on the office.

Fabric and ventilation specifications for the Office (refurbishment)

	Existing building	1. Business as usual ★	2. Good practice ★★	3. Ultra-low energy ★★★
Average floor U-value	1.0 W/m <sup>2</sup> K	1.0 W/m <sup>2</sup> K	1.0 W/m <sup>2</sup> K	0.09 W/m <sup>2</sup> K
Average wall U-value	2.1 W/m <sup>2</sup> K	2.1 W/m <sup>2</sup> K	0.3 W/m <sup>2</sup> K	0.13 W/m <sup>2</sup> K
Average roof U-value	1.4 W/m <sup>2</sup> K	0.18 W/m <sup>2</sup> K	0.18 W/m <sup>2</sup> K	0.10 W/m <sup>2</sup> K
Average window U-value	5.6 W/m <sup>2</sup> K	1.80 W/m <sup>2</sup> K	1.80 W/m <sup>2</sup> K	0.80 W/m <sup>2</sup> K
Thermal bridge performance	Ignored (5% of losses)	Ignored (5% of losses)	Ignored (5% of losses)	Best practice (1% of losses)
Ventilation	Natural ventilation	Natural ventilation	Standard quality MVHR	Best practice AHU
Ventilation system heat recovery efficiency	N/A	N/A	75%	90%
Ventilation system SFP	0.5 W/l/s - Extract	0.5 W/l/s - Extract	1.8 W/l/s	1.2 W/l/s
Airtightness	20m <sup>3</sup> /m <sup>2</sup> h	15m <sup>3</sup> /m <sup>2</sup> h	5m <sup>3</sup> /m <sup>2</sup> h	<1m <sup>3</sup> /m <sup>2</sup> h

Heating systems considered for the Office (refurbishment)

	Existing system	A. Gas boiler	B. VRF	C. Heat pump	D. Better heat pump
Heating Source	Gas boiler serving a heating system with flow and return temperature 70°C /50°C	Gas boiler serving a heating system with flow and return temperature 70°C /50°C	Direct electric panel radiators	Air source heat pumps serving a heating system with flow and return temperature 65°C/50°C	Ground source heat pumps serving a heating system with low flow and return temperature 45°C/40°C fed from a ground source array
Heating system	LTHW Fan Coil Unit fed by gas boiler	LTHW Fan Coil Unit fed by gas boiler	Fan Coil Unit fed by VRF	LTHW Fan Coil Unit fed by Reversible chiller/heat pump	LTHW Fan Coil Unit fed by Reversible chiller/heat pump
Hot water system	Direct electric hot water to toilets A 400L hot water store for the showers fed by gas boiler	Direct electric hot water to toilets A 400L hot water store for the showers fed by gas boiler	Direct electric hot water to toilets And electric showers	Direct electric hot water to toilets A 400L hot water store for the showers fed by the heat pump	Direct electric hot water to toilets A 800L hot water store for the showers fed by the heat pump
Heating and hot water seasonal efficiency	70%	95%	400% for heating 300% for hot water	220%	400% for heating 300% for hot water (top up 2nd stage heat pump)